

## HP.HPE0-V14.v2022-04-21.q157

Exam Code:	HPE0-V14
Exam Name:	Building HPE Hybrid IT Solutions
Certification Provider:	HP
Free Question Number:	157
Version:	v2022-04-21
# of views:	1951
# of Questions views:	1570
<a href="https://www.dumpsdb.com/dumps/HP/HPE0-V14/HP.HPE0-V14.v2022-04-21.q157">https://www.dumpsdb.com/dumps/HP/HPE0-V14/HP.HPE0-V14.v2022-04-21.q157</a>	

### NEW QUESTION: 1

A customer requires a management solution that will provide email notifications if hardware errors occur on their servers. Which management solution provides this functionality?

- A. HPE Intelligent Provisioning
- B. iLO Standard Edition
- C. Embedded UEFI diagnostics
- D. HPE Oneview

Answer: ([SHOW ANSWER](#))

### NEW QUESTION: 2

Refer to the exhibit.

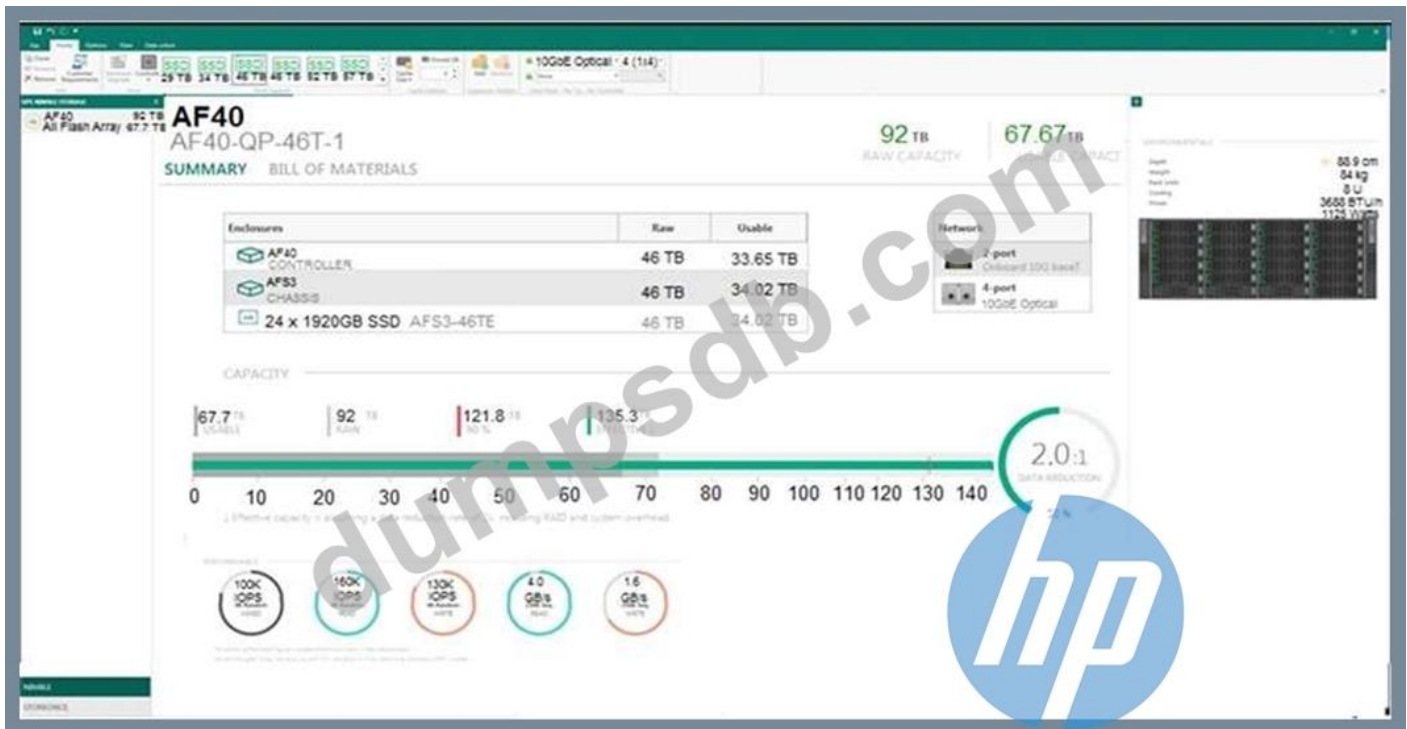

You are designing a new Nimble AF40 for your customer. The array will be added into an existing Nimble HF60 environment connected with SN6000B switches. You have created the configuration shown in the exhibit and noticed an error. What should you change in your configuration to ensure it meets the customer requirements?

- A. Change the controller to an HF20H.
- B. Change the controller to an AF20.
- C. Change the 10GbE Optical ports to Fibre Channel.
- D. Change the 10GbE Optical ports to 10BaseT.

**Answer: C** ([LEAVE A REPLY](#))

**NEW QUESTION: 3**

Match the characteristic to the correct HPE ProLiant family.

DL  ML

- Answer Area
- maximum 2 processors
  - maximum 4 processors
  - rack optimized
  - tower of rack

**Answer:**

DL  ML

- Answer Area
- ML  maximum 2 processors
  - DL  maximum 4 processors
  - DL  rack optimized
  - ML  tower of rack

Explanation

ML,DL,DL,ML

**NEW QUESTION: 4**

A customer needs a low cost block storage array for targeted workloads. The array needs to provide automated tiering, thin provisioning, and snapshot capabilities.

Which HPE storage solution meets the customer requirements?

- A. HPE MSA
- B. HPE D3000
- C. HPE Nimble
- D. HPE StoreEasy

**Answer: ([SHOW ANSWER](#))**

Explanation/Reference: <https://h20195.www2.hpe.com/v2/getpdf.aspx/A00015961ENW.pdf>

**NEW QUESTION: 5**

When should you choose to populate a server with LRDIMMs?

- A. when price is the most important factor
- B. when memory capacity is the most important factor
- C. when memory speed is the most important factor
- D. when error correction is the most important factor

**Answer: ([SHOW ANSWER](#))**

**NEW QUESTION: 6**

A solution Integrator is installing new equipment to the rack Click the recommended location area for R3000 Gen5 UPS.



**Answer:**



**NEW QUESTION: 7**

An HPE customer wants to perform a simplified update of firmware and drivers among their 100 HPE Gen9 and Gen10 racked servers.

Which HPE software tool should the customer use to minimize the time required to perform this activity.

- A. HPE ProLiant Support Pack
- B. HPE iLO Amplifier Pack
- C. HPE OneView Standard
- D. HPE Smart Update Manager

**Answer: B** ([LEAVE A REPLY](#))

**NEW QUESTION: 8**

When is it appropriate for a customer to implement HPE OneView Standard?

- A. To manage multiple servers
- B. To monitor their services

- C. To enable the Advanced iLO license
- D. To update firmware

**Answer: (SHOW ANSWER)**

Explanation/Reference: <https://h20195.www2.hp.com/v2/GetPDF.aspx/c04111367.pdf>

**NEW QUESTION: 9**

A customer is considering an upgrade of their network, which connects 10 servers. The customer has a converged data center networking architecture with Layer 2 and Layer 3 functionality. Which HPE product family will meet this customer's needs?

- A. Arista
- B. Altoline
- C. Aruba
- D. FlexFabric

**Answer: (SHOW ANSWER)**

Explanation

B

**NEW QUESTION: 10**

Match each customer data center architecture to its network topology.

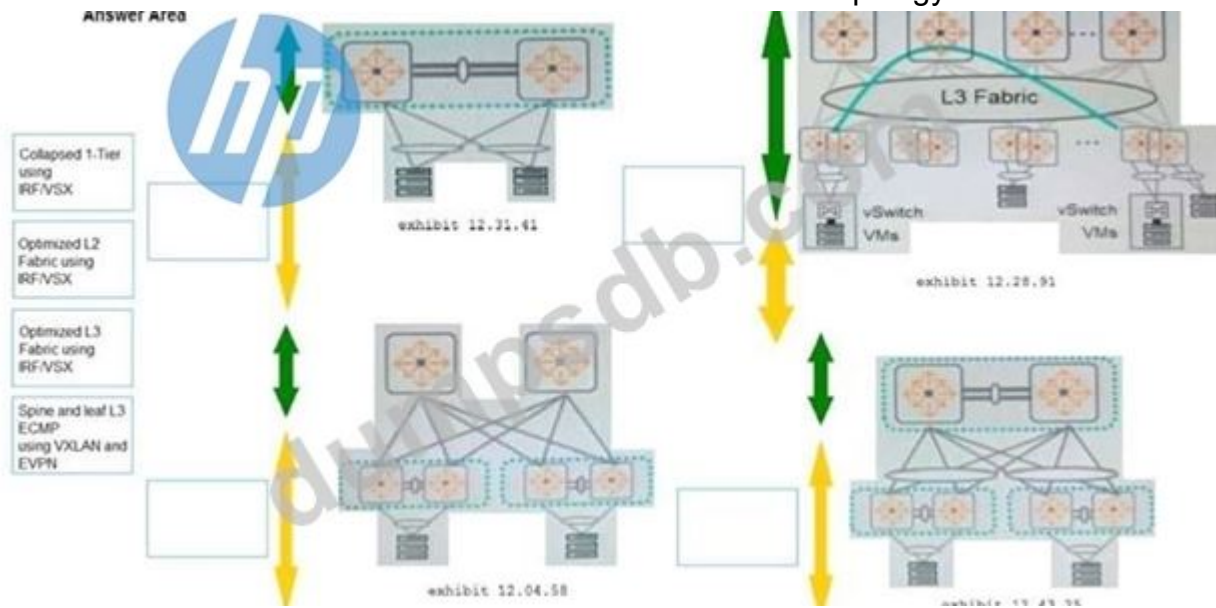

**Answer:**

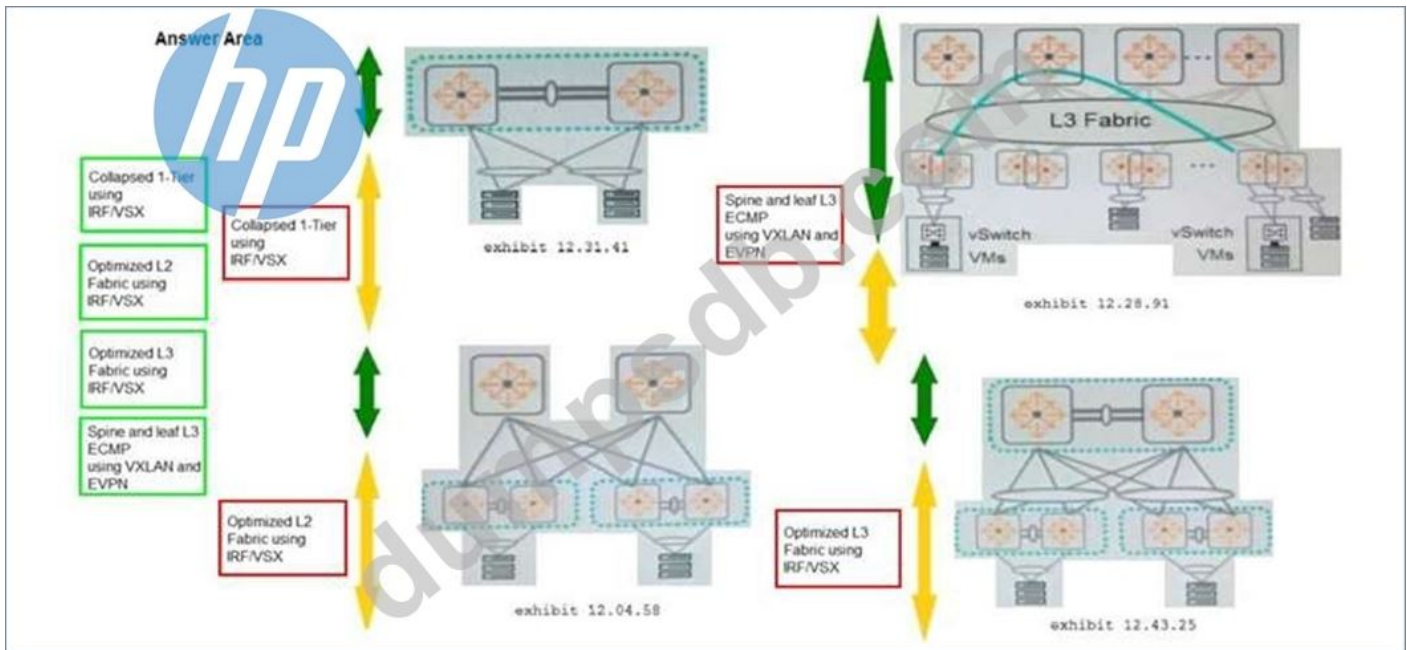

**NEW QUESTION: 11**

A customer needs a low cost block storage array for targeted workloads. The array needs to provide automated tiering, thin provisioning, and snapshot capabilities.

Which HPE storage solution meets the customer requirements?

- A. HPE StoreEasy
- B. HPE D3000
- C. HPE MSA
- D. HPE Nimble

**Answer: C (LEAVE A REPLY)**

**NEW QUESTION: 12**

Match the industry trend with its use case.

Industry Trend	Use Case
Cloud Computing	Efficiently use server, storage, and networking resources
Converged Systems	Externalize the infrastructure and eliminate data center capital expenditures
Virtualization	Share a common resource or execute a common application across multiple servers for high availability and/or load balancing
Clustering	Deploy workloads at cloud-like speed on an HPE factory-integrated infrastructure

**Answer:**

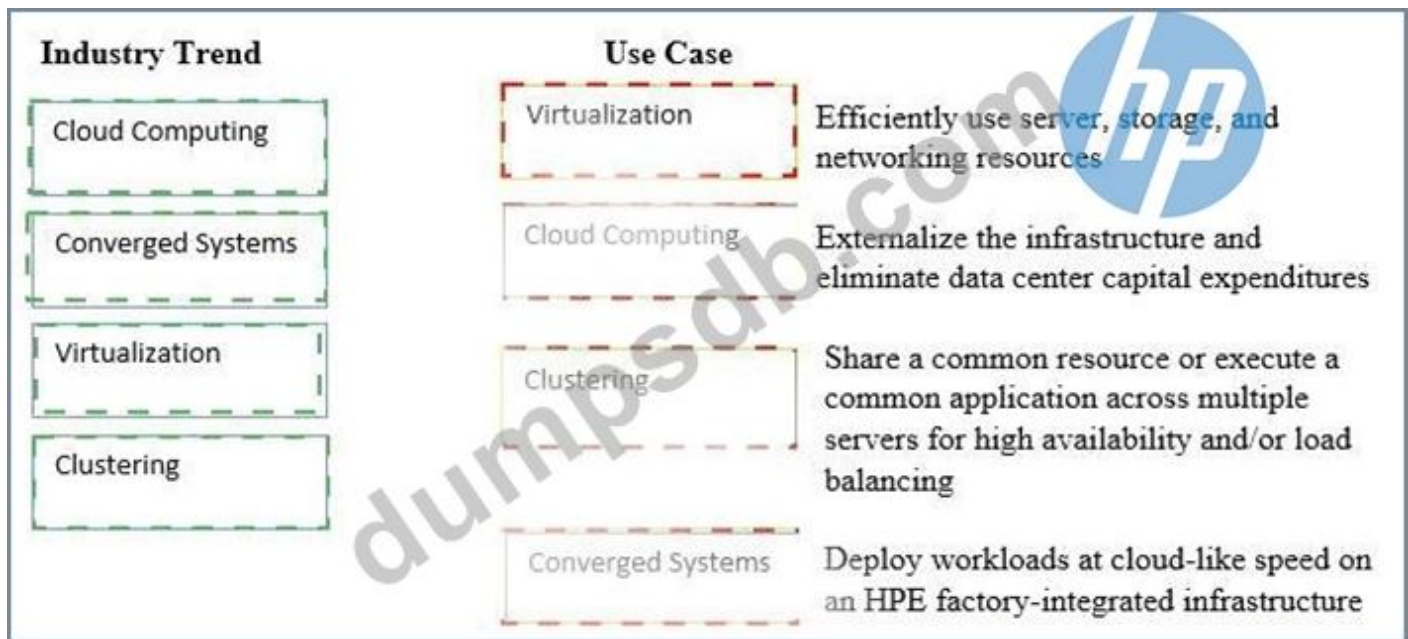

**Explanation**

Efficiently use server, storage, and networking resources - Virtualization  
 Externalize the infrastructure and eliminate data center capital expenditures - Cloud computing  
 Share a common resource or execute a common application across multiple servers for high availability and/or load balancing - Clustering  
 Deploy workloads at cloud-like speed on an HPE factory-integrated infrastructure - Converged system

**NEW QUESTION: 13**

Match each HPE solution to its corresponding technology usage.

**HPE Solution**

**Usage**

HPE OneView  
Advanced

single-pane management and monitoring for selected HPE devices

HPE ProLiant

industry-leading server platform for a broad range of workloads

HPE Simplivity

purpose-built hyperconverged solution

**Answer:**

HPE Solution		Usage
HPE OneView Advanced	HPE OneView Advanced	single-pane management and monitoring for selected HPE devices
HPE ProLiant	HPE ProLiant	industry-leading server platform for a broad range of workloads
HPE Simplivity	HPE Simplivity	purpose-built hyperconverged solution

Explanation

### Answer Area

HPE Solution		Usage
HPE OneView Advanced	HPE OneView Advanced	single-pane management and monitoring for selected HPE devices
HPE ProLiant	HPE ProLiant	industry-leading server platform for a broad range of workloads
HPE Simplivity	HPE Simplivity	purpose-built hyperconverged solution

### NEW QUESTION: 14

Which protocol should be used to access an exported directory on a network-attached storage device?

- A. NFS
- B. RIP
- C. SNMP
- D. BGP

Answer: A ([LEAVE A REPLY](#))

### NEW QUESTION: 15

What is an access port on an Ethernet switch?

- A. A port that is connected to an FCF
- B. A port that carries multiple VLANs
- C. A port that carries FCP frames inside the network
- D. A port that carries untagged frames inside the network

Answer: D ([LEAVE A REPLY](#))

### NEW QUESTION: 16

What does StoreOnce use to allow independent software vendors (ISV) to be aware of the HPE StoreOnce Backup system and its capabilities without emulation?

- A. Recovery Manager Central
- B. Catalyst Target
- C. Virtual Tape Library
- D. NAS Target

**Answer: (SHOW ANSWER)**

Reference:

[https://www.hpe.com/emea\\_europe/en/storage/rmc-backup.html](https://www.hpe.com/emea_europe/en/storage/rmc-backup.html)

**Valid HPE0-V14 Dumps** shared by TrainingQuiz.com for Helping Passing HPE0-V14 Exam! TrainingQuiz.com now offer the **newest HPE0-V14 exam dumps**, the TrainingQuiz.com HPE0-V14 exam **questions have been updated** and **answers have been corrected** get the **newest** TrainingQuiz.com HPE0-V14 dumps with Test Engine here:

<https://www.trainingquiz.com/HPE0-V14-practice-quiz.html> (305 Q&As Dumps, **40%OFF**)

**Special Discount: Exam-Tests)**

#### **NEW QUESTION: 17**

What has HPE implemented in the HPE ProLiant Gen10 to prevent malware?

- A. persistent memory
- B. silicon root of trust
- C. application isolation control
- D. jitter smoothing

**Answer: B (LEAVE A REPLY)**

#### **NEW QUESTION: 18**

A customer is expanding from local storage to a SAN environment for the first time. They plan to future proof their environment with a 16 Gb Fibre Channel. They also want to allow for future I/O expansion with new servers.

Identify the correct server and storage to meet the customer requirements.



**Answer:**

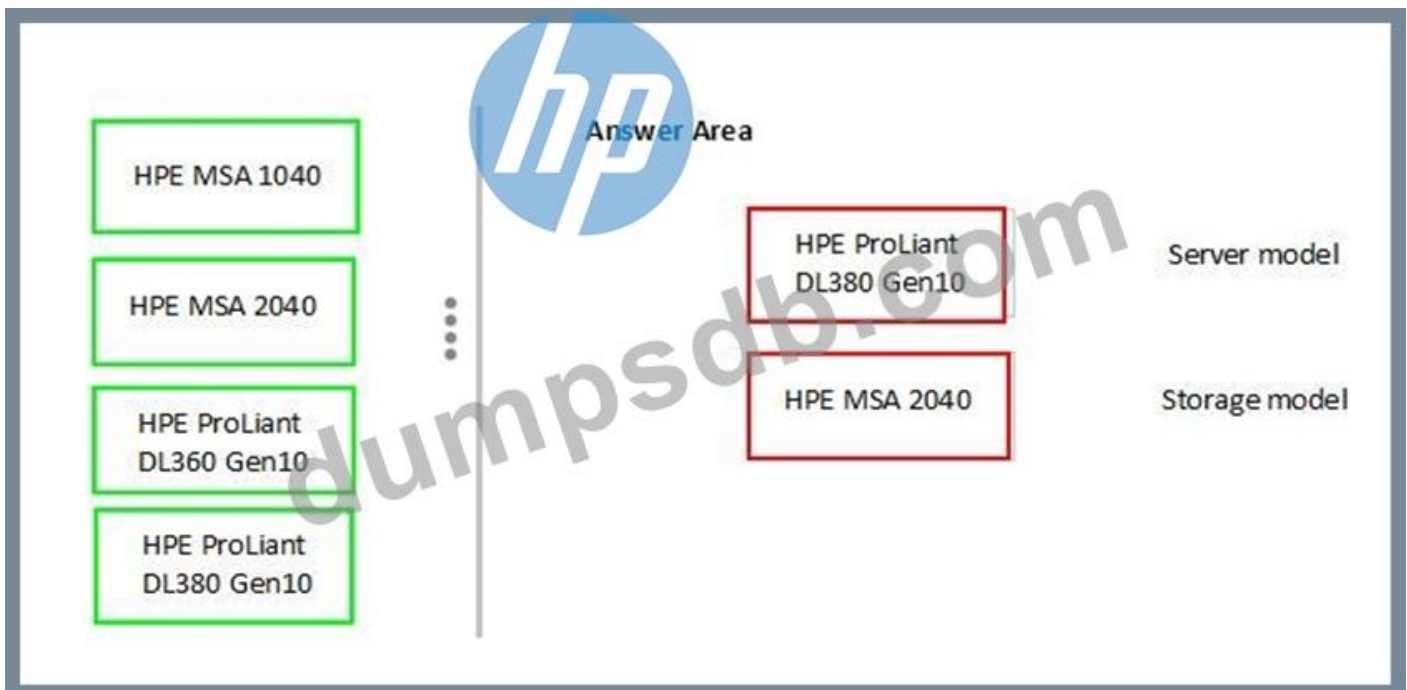

**NEW QUESTION: 19**

A customer needs a single, dual-processor server for an Enterprise Resource Planning solution for a single office. The customer application uses a mix of HDDs and SSDs and up to 3TB of RAM.

Which HPE Solution should you propose?

- A. HPE Synergy Solution
- B. HPE Apollo 2000 Server
- C. HPE ML350 Gen10
- D. HPE ML110 Gen10

**Answer: C (LEAVE A REPLY)**

**NEW QUESTION: 20**

Match each HPE solution to its corresponding technology usage.

HPE Solution		Usage
HPE OneView Advanced	<input type="text"/>	single-pane management and monitoring for selected HPE devices
HPE ProLiant	<input type="text"/>	industry-leading server platform for a broad range of workloads
HPE Simplivity	<input type="text"/>	purpose-built hyperconverged solution

**Answer:**

HPE Solution		Usage
HPE OneView Advanced	HPE OneView Advanced	single-pane management and monitoring for selected HPE devices
HPE ProLiant	HPE ProLiant	industry-leading server platform for a broad range of workloads
HPE Simplivity	HPE Simplivity	purpose-built hyperconverged solution

Explanation

**ANSWER AREA**

HPE Solution		Usage
HPE OneView Advanced	HPE OneView Advanced	single-pane management and monitoring for selected HPE devices
HPE ProLiant	HPE ProLiant	industry-leading server platform for a broad range of workloads
HPE Simplivity	HPE Simplivity	purpose-built hyperconverged solution

**NEW QUESTION: 21**

A customer needs to move from their traditional tape-based backup infrastructure to a standalone application to disk based backup solution using HPE StoreOnce. The environment does not use a hypervisor.

The customer has the following goals for their long-term backup retention:

retain data for over two years at low cost

data is archival and rarely accessed, if ever

Which HPE StoreOnce components can help meet the customer goals in the most cost effective manner? (Choose three.)

- A. Catalyst Replication license
- B. HPE StoreOnce 35xx
- C. HPE StoreOnce Cloud Bank Storage license
- D. HPE StoreOnce VSA
- E. Azure Cloud or S3 object store

**Answer: A,C,D (LEAVE A REPLY)**

**NEW QUESTION: 22**

Match each workload profile description with the corresponding profile. (Select all that apply.)

Profile		Description
Mission Critical	<input type="text"/>	Maximizes processor speed
Transactional Application Processing	<input type="text"/>	Large number of database operations
General Peak Frequency Compute	<input type="text"/>	Trades performance for reliability

**Answer:**

Profile		Description
Mission Critical	General Peak Frequency Compute	Maximizes processor speed
Transactional Application Processing	Mission Critical	Large number of database operations
General Peak Frequency Compute	Transactional Application Processing	Trades performance for reliability

Explanation

Missing Critical - Large number of database operations

Transactional Application Processing - Trades performance for reliability

General Peak Frequency Compute - Maximize processor speed

**NEW QUESTION: 23**

When configuring a single ProLiant Gen10 server, which embedded tool can be used to deploy a reliable and consistent configuration?

- A. Intelligent Provisioning
- B. HPE iLO Amplifier Pack
- C. Smart Update Manager
- D. HPE OneView

**Answer: A ([LEAVE A REPLY](#))**

**NEW QUESTION: 24**

A customer needs a virtual desktop infrastructure environment to quickly deploy new desktop images to more than 70 onsite contractors. They plan to use HPE ProLiant DL360 Gen10 servers running VMware ESXi connected to a shared storage device. The customer requires deduplication because they are concerned about the required storage capacity for the full clone images.

Which storage device would best address their concerns?

- A. HPE MSA 1040
- B. HPE MSA 2052
- C. HPE Nimble AF20
- D. HPE Nimble HF20C

**Answer: ([SHOW ANSWER](#))**

Explanation/Reference:

Reference: [https://h20628.www2.hp.com/km-ext/kmcsdirect/emr\\_na-a00050816en\\_us-5.pdf](https://h20628.www2.hp.com/km-ext/kmcsdirect/emr_na-a00050816en_us-5.pdf)

**NEW QUESTION: 25**

You are installing a DL385 GEN10 LFF server at a customer site. The customer has a P8i6i-a RAID controller in the host. After installing the provided 8 LFF disks in the front drive bays, you realize that the order also included two more SFF drives for the OS to boot from, but there are no SFF drive slots in the server, because it shipped from the factory.

Which action must be performed to finish the installation?

- A. Order the optional Premium 6 SAS/SATA+2 NVMe cage to house the two SFF drives.
- B. Install the two SFF drives in the two included SFF slots in the universal Media Bay.
- C. Give the two SFF drives to the customer to keep on-site in case of future drive failure.
- D. Order the optional 2-SFF rear drive box to house the two SFF drives

**Answer: B ([LEAVE A REPLY](#))**

**NEW QUESTION: 26**

A customer needs to locate an exact time when a link down event occurred at the FC port of Nimble storage. Which on-premises tool can the customer use?

- A. Embedded UEFI Diagnostics
- B. HPE StoreServ Management Console

- C. HPE InfoSight
- D. HPE Nimble Storage web-based user interface

Answer: ([SHOW ANSWER](#))

**NEW QUESTION: 27**

A customer wants to install an HPE ProLiant server that has a single dual port 10Gb NIC. Which NIC feature should you introduce to allow each 10Gb port to be seen as four individual adapters in the operating system?

- A. RDMA
- B. FCoE
- C. NPAR
- D. RoCE

Answer: ([SHOW ANSWER](#))

**NEW QUESTION: 28**

Which feature in a block storage array is effective in decreasing the size of blocks?

- A. deduplication
- B. thin provisioning
- C. compression
- D. thick provisioning

Answer: C ([LEAVE A REPLY](#))

**NEW QUESTION: 29**

Match each ProLiant solution to its ideal use case

ProLiant Solution	Use Case
HPE ProLiant MicroServer Gen10	Dense, racked, multi-server deployments; scales up to handle enterprise workloads
HPE ProLiant ML30 Gen10 Server	Non-racked environments; able to scale large enough to handle enterprise workloads
HPE ProLiant ML350 Gen10 Server	Non-racked environments; limited scale and expandability; single processor; dual power supply
HPE ProLiant DL380 Gen10 Server	Small form factor; optimized for small or home office; quiet operational noise level; low cost

Answer:

### ProLiant Solution

HPE ProLiant MicroServer Gen10
HPE ProLiant ML30 Gen10 Server
HPE ProLiant ML350 Gen10 Server
HPE ProLiant DL380 Gen10 Server

### Use Case

HPE ProLiant DL380 Gen10 Server	Dense racked, multi-server deployments; scales up to handle enterprise workloads
HPE ProLiant ML350 Gen10 Server	Non-racked environments; able to scale large enough to handle enterprise workloads
HPE ProLiant ML30 Gen10 Server	Non-racked environments; limited scale and expandability; single processor; dual power supply
HPE ProLiant MicroServer Gen10	Small form factor; optimized for small or home office; quiet operational noise level; low cost

Explanation

4 , 3 , 2 , 1

### NEW QUESTION: 30

Which HPE ProLiant server should you recommend for a home office environment where the server will be located in the same office as the user?

- A. HPEXL170r
- B. HPE ML110
- C. HPE DL20
- D. HPE MicroServer

Answer: D ([LEAVE A REPLY](#))

### NEW QUESTION: 31

A customer requires a software-defined storage solution.

Which storage solution meets the customer's needs?

- A. HPE MSA
- B. HPE Nimble Storage
- C. HPE StoreVirtual VSA
- D. HPE 3PAR StoreServ

Answer: C ([LEAVE A REPLY](#))

**Valid HPE0-V14 Dumps** shared by TrainingQuiz.com for Helping Passing HPE0-V14 Exam! TrainingQuiz.com now offer the **newest HPE0-V14 exam dumps**, the TrainingQuiz.com HPE0-V14 exam **questions have been updated** and **answers have been corrected** get the **newest** TrainingQuiz.com HPE0-V14 dumps with Test Engine here:

<https://www.trainingquiz.com/HPE0-V14-practice-quiz.html> (305 Q&As Dumps, **40%OFF**)

Special Discount: **Exam-Tests**)

### NEW QUESTION: 32

A customer is considering an upgrade of their networking infrastructure with HPE FlexFabric 5940 series switch.

Match the fan tray option with the airflow direction.

**Answer Area**

<input type="checkbox"/>	<input type="text"/>	HPE 58x0AF Power-to-Port Airflow Fan Tray
<input type="checkbox"/>	<input type="text"/>	HPE 58x0AF Port-to-Port Airflow Fan Tray
<input type="checkbox"/>	<input type="text"/>	HPE X711 Port-to-Power Airflow High Volume Fan Tray
<input type="checkbox"/>	<input type="text"/>	HPE X712 Power-to-Port Airflow High Volume Fan Tray

**Answer:**  
**Answer Area**

<input type="checkbox"/>	<input type="text"/>	HPE 58x0AF Power-to-Port Airflow Fan Tray
<input type="checkbox"/>	<input type="text"/>	HPE 58x0AF Port-to-Port Airflow Fan Tray
<input type="checkbox"/>	<input type="text"/>	HPE X711 Port-to-Power Airflow High Volume Fan Tray
<input type="checkbox"/>	<input type="text"/>	HPE X712 Power-to-Port Airflow High Volume Fan Tray

Explanation

**Answer Area**

<input type="checkbox"/>	<input type="text"/>	HPE 58x0AF Power-to-Port Airflow Fan Tray
<input type="checkbox"/>	<input type="text"/>	HPE 58x0AF Port-to-Port Airflow Fan Tray
<input type="checkbox"/>	<input type="text"/>	HPE X711 Port-to-Power Airflow High Volume Fan Tray
<input type="checkbox"/>	<input type="text"/>	HPE X712 Power-to-Port Airflow High Volume Fan Tray

<https://h20195.www2.hpe.com/v2/GetDocument.aspx?docname=c05158726#>

**NEW QUESTION: 33**

Refer to the exhibit.

```
<Switch-A>display int Ten-GigabitEthernet 1/0/1 Ten-GigabitEthernet1/0/1 Current state: UP
Line protocol state: UP IP packet frame type: Ethernet II, hardware address: d894-03fb-793d
Description: Ten-GigabitEthernet1/0/1 Interface Bandwidth: 10000000 kbps Loopback is not
set Media type is stack wire, port hardware type is STACK_SFP_PLUS 10Gbps-speed mode, full-
duplex mode Link speed type is autonegotiation, link duplex type is autonegotiation Flow-
control is not enabled Maximum frame length: 10000 Allow jumbo frames to pass Broadcast
max-ratio: 100% Multicast max-ratio: 100% Unicast max-ratio: 100% PVID: 1 MDI type:
Automdix Port link-type: Trunk VLAN Passing: 10, 20 VLAN permitted: 10, 20 Trunk port
encapsulation: IEEE 802.1q Port priority: 0 <SNIP>
```

An administrator connected a hypervisor to interface Ten-GigabitEthernet1/0/1 in a switch. The administrator created virtual machines in VLAN 10 and 20 on the hypervisor. VLAN 10 is configured to be tagged, and VLAN 20 is configured to be untagged on the hypervisor. The administrator found that all the virtual machines in VLAN 20 can communicate with each other, but not with any virtual machines on VLAN 20 external to the hypervisor. Given the output in the exhibit, what should you do to resolve the issue?

- A. Configure the interface as an IRF port.
- B. Permit VLAN 1 on the interface.
- C. Configure the interface as an access port.
- D. Configure the PVID of the interface to be VLAN 20.

**Answer: A (LEAVE A REPLY)**

#### NEW QUESTION: 34

A customer has requested that you provide them with an architecture and bill-of-materials for a stack of top-of-rack switches. The customer has 34 HPE DL360 servers in the rack, each with four 1GBASE-T Ethernet ports which need to be connected to the network.

The customer is upgrading 50% of the 1GBASE-T Ethernet ports on the servers to 10GBASE-T Ethernet ports and needs the switching to support the upgraded servers. They are opposed to a chassis switch, and want to keep the number of managed devices on the network to a minimum. Which architecture meets the customer requirements?

- A. One VSX stack of four Aruba 8320 48-port 1/10GBASE-T switches
- B. Two IRF stacks of two HPE 5710 48-port 1/10GBASE-T switches
- C. One IRF stack of four HPE 5710 48-port 1/10GBASE-T switches
- D. Two VSX stacks of two Aruba 8320 48-port 1/10GBASE-T switches

**Answer: C (LEAVE A REPLY)**

Explanation

Needs 4 switches for port count, customer wants minimum of managed devices so one stack, VSX only supports two switches so must be an IRF based stack. As to ShaunSong's comment, 10GBaseT ports also negotiate 1000BaseT so are inherently 1/10Gb capable.

#### NEW QUESTION: 35

Match the feature to the lowest iLO5 license in which it is available

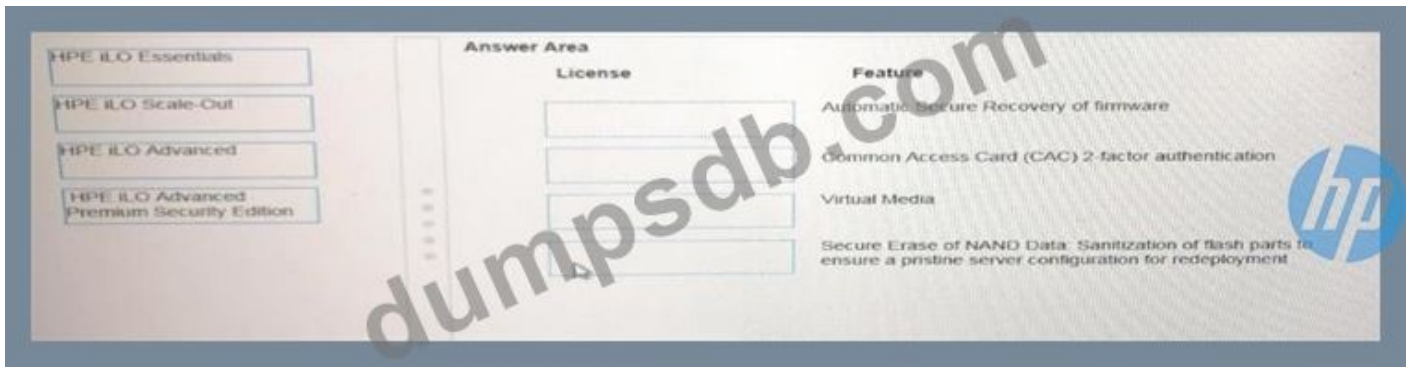

**Answer:**

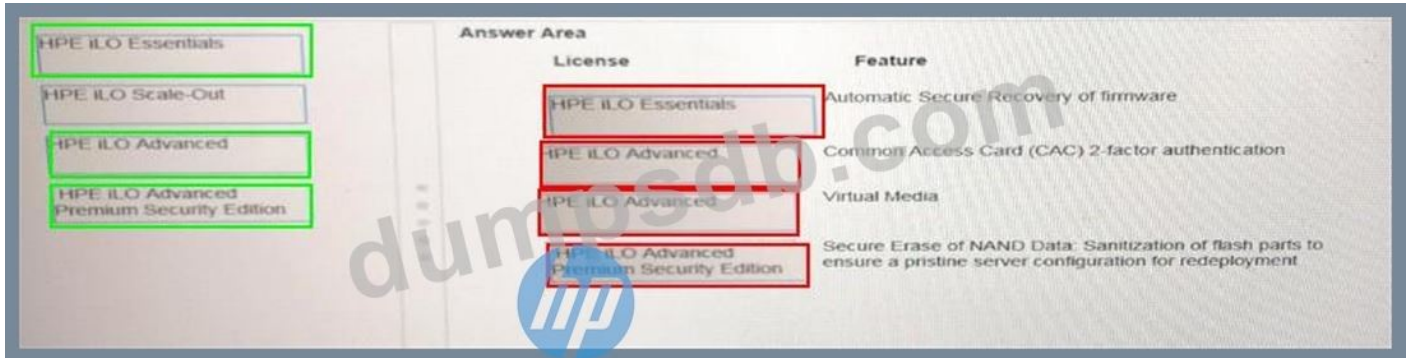

Last - last

3-2

1-1

3-3

**NEW QUESTION: 36**

A security client needs a surveillance solution to support 239 Cameras. They expect to generate 2PB of data and require a 10Gb network infrastructure in a single rack.

Which solution should you recommend to meet the customer requirements?

- A. HPE Moonshot
- B. HPE MSA
- C. HPE Apollo Servers
- D. HPE SimpliVity 380

**Answer: C (LEAVE A REPLY)**

Explanation/Reference: <https://h20195.www2.hp.com/v2/GetPDF.aspx/4AA0-6064ENW.pdf>

**NEW QUESTION: 37**

Match each ProLiant solution to its ideal use case

**ProLiant Solution**

**Use Case**

HPE ProLiant  
MicroServer Gen10

Dense, racked, multi-server deployments;  
scales up to handle enterprise workloads

HPE ProLiant ML30  
Gen10 Server

Non-racked environments; able to scale  
large enough to handle enterprise  
workloads

HPE ProLiant  
ML350 Gen10  
Server

Non-racked environments; limited scale  
and expandability; single processor; dual  
power supply

HPE ProLiant  
DL380 Gen10  
Server

Small form factor; optimized for small or  
home office; quiet operational noise level;  
low cost



**Answer:**

**ProLiant Solution**

**Use Case**

HPE ProLiant  
MicroServer Gen10

HPE ProLiant  
DL380 Gen10  
Server

Dense, racked, multi-server deployments;  
scales up to handle enterprise workloads

HPE ProLiant ML30  
Gen10 Server

HPE ProLiant  
ML350 Gen10  
Server

Non-racked environments; able to scale  
large enough to handle enterprise  
workloads

HPE ProLiant  
ML350 Gen10  
Server

HPE ProLiant ML30  
Gen10 Server

Non-racked environments; limited scale  
and expandability; single processor; dual  
power supply

HPE ProLiant  
DL380 Gen10  
Server

HPE ProLiant  
MicroServer Gen10

Small form factor; optimized for small or  
home office; quiet operational noise level;  
low cost



4 , 3 , 2 , 1

**NEW QUESTION: 38**

Exhibit:

-2vCPU  
-8 GB RAM  
-1 Gb dedicated network  
-50 GB Disk

Which HPE ProLiant Server meets the customer's requirements?



- A. Option C
- B. Option D
- C. Option B
- D. Option A

**Answer: C** ([LEAVE A REPLY](#))

**NEW QUESTION: 39**

Which web service uses basic CRUD operations performed on resources using HTTP Post, Get, Put, Delete, and Patch?

- A. SOAP
- B. cURL
- C. REST
- D. CORBA

**Answer: A** ([LEAVE A REPLY](#))

**NEW QUESTION: 40**

A customer is considering an upgrade of their networking infrastructure with HPE FlexFabric 5940 series switch.

Match the fan tray option with the airflow direction.

### Answer Area

	<input type="text"/>	HPE 58x0AF Power-to-Port Airflow Fan Tray
<input type="text" value="Front to back"/>	<input type="text"/>	HPE 58x0AF Port-to-Port Airflow Fan Tray
<input type="text" value="Back to front"/>	<input type="text"/>	HPE X711 Port-to-Power Airflow High Volume Fan Tray
	<input type="text"/>	HPE X712 Power-to-Port Airflow High Volume Fan Tray

Answer:

### Answer Area

	<input type="text" value="Back to front"/>	HPE 58x0AF Power-to-Port Airflow Fan Tray
<input type="text" value="Front to back"/>	<input type="text" value="Front to back"/>	HPE 58x0AF Port-to-Port Airflow Fan Tray
<input type="text" value="Back to front"/>	<input type="text" value="Front to back"/>	HPE X711 Port-to-Power Airflow High Volume Fan Tray
	<input type="text" value="Back to front"/>	HPE X712 Power-to-Port Airflow High Volume Fan Tray

Explanation

### Answer Area

	<input type="text" value="Back to front"/>	HPE 58x0AF Power-to-Port Airflow Fan Tray
<input type="text" value="Front to back"/>	<input type="text" value="Front to back"/>	HPE 58x0AF Port-to-Port Airflow Fan Tray
<input type="text" value="Back to front"/>	<input type="text" value="Front to back"/>	HPE X711 Port-to-Power Airflow High Volume Fan Tray
	<input type="text" value="Back to front"/>	HPE X712 Power-to-Port Airflow High Volume Fan Tray

### NEW QUESTION: 41

A customer's backup administrator is responsible for maintaining and coordinating all nightly backups of the company's 30 servers.

Which HPE product can be used as the primary interface to orchestrate all backup targets and Catalyst copy functions?

- A. Smart Storage Administrator
- B. HPE StoreServ
- C. Intelligent Provisioning
- D. StoreOnce Management Console

Answer: D ([LEAVE A REPLY](#))

**NEW QUESTION: 42**

Match each adapter to its characteristic.

**Answer Area**

Adapter		Characteristic
FlexLOM	<input type="text"/>	provide RAID configuration using disks internal to the server
FlexFabric	<input type="text"/>	allow choice of network interface on the motherboard
Smart Array	<input type="text"/>	connect to native Fibre Channel SAN with a PCIe adapter
HBA	<input type="text"/>	connect to a Fibre Channel over Ethernet (FCoE) SAN environment with a PCIe adapter

**Answer:**

**Answer Area**

Adapter		Characteristic
FlexLOM	Smart Array	provide RAID configuration using disks internal to the server
FlexFabric	FlexLOM	allow choice of network interface on the motherboard
Smart Array	HBA	connect to native Fibre Channel SAN with a PCIe adapter
HBA	FlexFabric	connect to a Fibre Channel over Ethernet (FCoE) SAN environment with a PCIe adapter

Explanation

**Answer Area**

Adapter		Characteristic
FlexLOM	Smart Array	provide RAID configuration using disks internal to the server
FlexFabric	FlexLOM	allow choice of network interface on the motherboard
Smart Array	HBA	connect to native Fibre Channel SAN with a PCIe adapter
HBA	FlexFabric	connect to a Fibre Channel over Ethernet (FCoE) SAN environment with a PCIe adapter

**NEW QUESTION: 43**

Match each HPE solution to its optimal use case.

Select and Place:

**Answer Area**



HPE Solution	Use Case
HPE Proliant Microserver	General Purpose Computing, Virtualization Clusters, Enterprise Applications
HPE Proliant ML/DL	NAS Storage, File Sync and Share for Remote/Mobile users
HPE StoreEasy	Remote Office, Low Cost, Quiet Operation, Office environment
HPE StoreOnce	Space-efficient Backups, Backup Replication, Cloud-based Archiving

Answer:

Answer Area

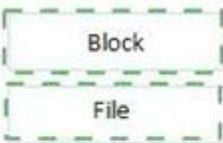

Technology	Type
Block	ISCSI
File	CIFS
Block	SAN
File	NFS



Explanation

**Answer Area**

**HPE Solution**

**Use Case**



HPE Proliant Microserver	HPE Proliant ML/DL	General Purpose Computing, Virtualization Clusters, Enterprise Applications
HPE Proliant ML/DL	HPE StoreEasy	NAS Storage, File Sync and Share for Remote/Mobile users
HPE StoreEasy	HPE Proliant Microserver	Remote Office, Low Cost, Quiet Operation, Office environment
HPE StoreOnce	HPE StoreOnce	Space-efficient Backups, Backup Replication, Cloud-based Archiving

**NEW QUESTION: 44**

Drag the correct protocols from the left to their appropriate area on the topology.

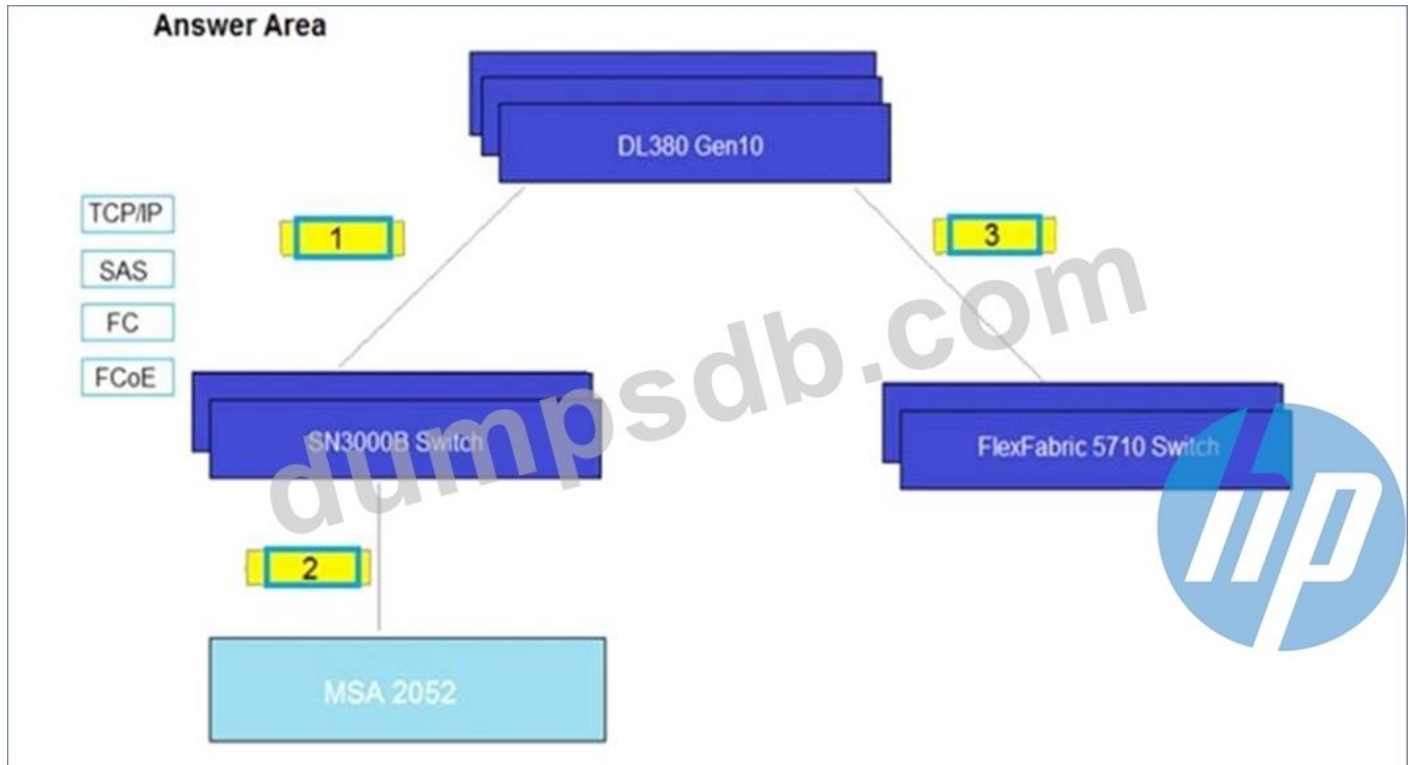

**Answer:**

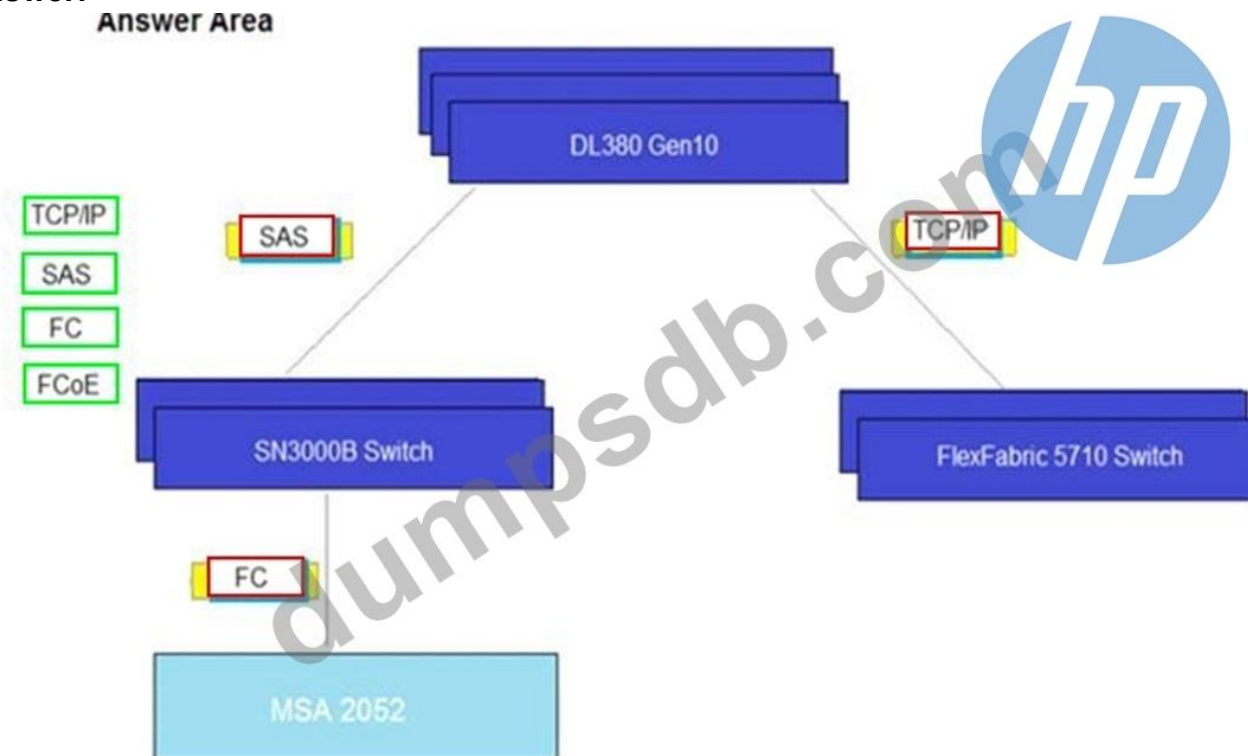

**NEW QUESTION: 45**

A customer has a single HPE ProLiant Gen 10 server.

Which embedded management tool should they use to monitor the server?

- A. HPE OneView Standard**

- B. HPE Smart Update Manager
- C. NPE Intelligent Provisioning
- D. HPE iLO5

**Answer: (SHOW ANSWER)**

Explanation/Reference: <https://dustinweb.azureedge.net/media/483889/proliant-dl380-gen10-smb.pdf>

**NEW QUESTION: 46**

Place the components on the left in the correct order on the right for the recommended power-up sequence.

Components	Order
Disk storage	
Host servers	
SAN switches	
Tape libraries	

**Answer:**

Components	Order
Disk storage	SAN switches
Host servers	Tape libraries
SAN switches	Disk storage
Tape libraries	Host servers



- \* SAN switches
- \* Tape libraries
- \* Disk storage
- \* Host servers

**Valid HPE0-V14 Dumps** shared by TrainingQuiz.com for Helping Passing HPE0-V14 Exam! TrainingQuiz.com now offer the **newest HPE0-V14 exam dumps**, the TrainingQuiz.com HPE0-V14 exam **questions have been updated** and **answers have been corrected** get the **newest** TrainingQuiz.com HPE0-V14 dumps with Test Engine here:

<https://www.trainingquiz.com/HPE0-V14-practice-quiz.html> (305 Q&As Dumps, **40%OFF**

**Special Discount: Exam-Tests)**

**NEW QUESTION: 47**

A security client needs a surveillance solution to support 239 Cameras. They expect to generate 2PB of data and require a 10Gb network infrastructure in a single rack.

Which solution should you recommend to meet the customer requirements?

- A. HPE Moonshot
- B. HPE MSA
- C. HPE Apollo Servers
- D. HPE SimpliVity 380

**Answer: C (LEAVE A REPLY)**

Reference:

<https://h20195.www2.hp.com/v2/GetPDF.aspx/4AA0-6064ENW.pdf>

**NEW QUESTION: 48**

Match the Networking Product Family to the appropriate use case:

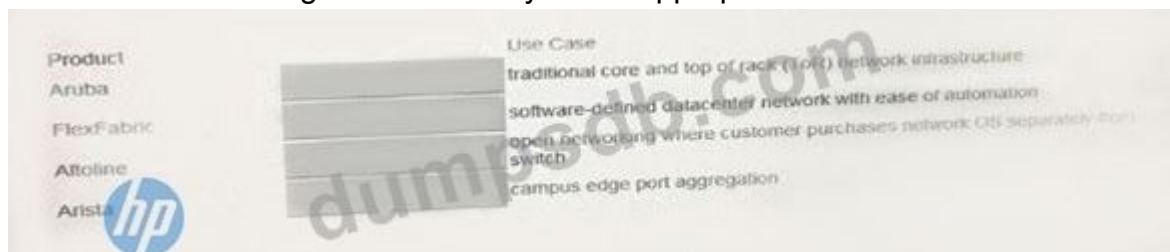

**Answer:**



**NEW QUESTION: 49**

Match each customer data center architecture to its network topology.

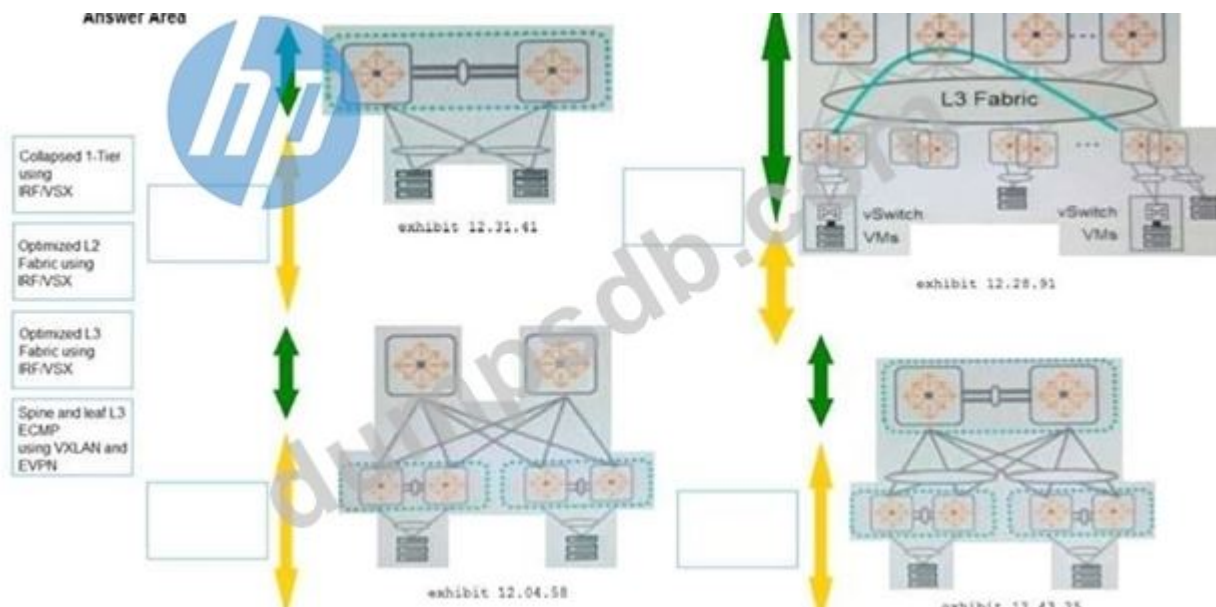

**Answer:**

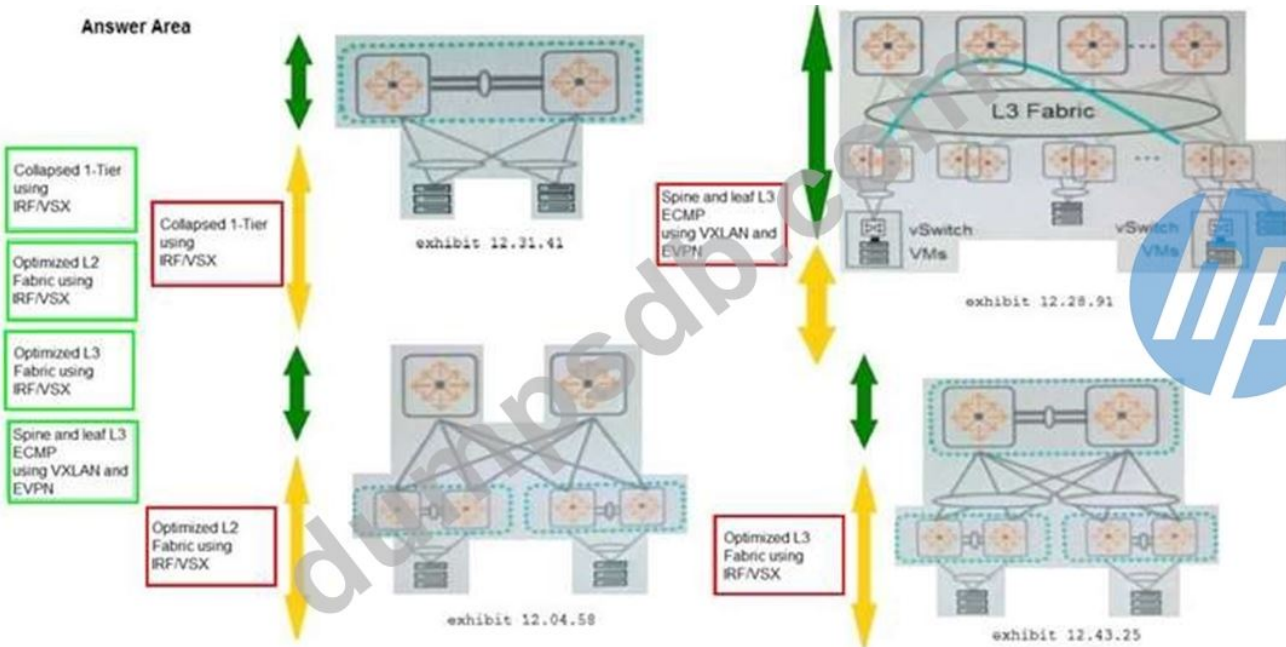

**NEW QUESTION: 50**

A customer needs to enable HPE Proactive Care and automated case creation for server hardware failures in their OneView environment.

Which step do you need to complete in OneView to accomplish these tasks?

- A. Configure proactive scan reports.
- B. Enable remote support from the Settings page.
- C. Add the hosts to the managed devices group.
- D. Apply the OneView Advanced monitoring license.

**Answer:** ([SHOW ANSWER](#))

**NEW QUESTION: 51**

Refer to the exhibit.

Qty	Product Description
1	HPE ProLiant DL380 Gen10 8SFF Configure-to-order Server
1	HPE DL380 Gen10 8SFF CTO Server
1	HPE DL380 Gen10 Intel Xeon-Gold 6143 (2.8GHz/16-core/205W) FIO Processor Kit
1	HPE DL380 Gen10 Intel Xeon-Gold 6143 (2.8GHz/16-core/205W) Processor Kit
16	HPE 32GB (1x32GB) Dual Rank x4 DDR4-2666 CAS-19-19-19 Registered Smart Memory Kit
2	HPE 480GB SATA 6G Mixed Use SFF (2.5in) SC 3yr Wty Digitally Signed Firmware SSD
1	HPE Ethernet 10Gb 2-port 562SFP+ Adapter
1	HPE Smart Array P408i-a SR Gen10 (8 Internal Lanes/2GB Cache) 12G SAS Modular Controller
1	HPE 96W Smart Storage Battery (up to 20 Devices) with 145mm Cable Kit
1	HPE Ethernet 10Gb 2-port 562FLR-SFP+ Adapter
1	HPE RAID 1 Drive 1 FIO Setting
1	HPE DL38X Gen10 High Performance Temperature Fan Kit
1	HPE 800W Flex Slot Platinum Hot Plug Low Halogen Power Supply Kit
1	HPE 2U Small Form Factor Easy Install Rail Kit

You are asked to review a server configuration for a customer before it is quoted. The server will be used in a business-critical environment and high availability is required. The server configuration is shown in the exhibit.

What should be added to the configuration to ensure availability?

- A. HPE DL380 Gen10 Intel Xeon-Gold 6143 (2.8 GHz/16-core/205 W) Processor Kit
- B. HPE 800W Flex Slot Platinum Hot Plug Low Halogen Power Supply Kit
- C. HPE DL38X Gen10 12 Gb SAS Expander Card Kit
- D. HPE Smart Array P408i-a SR Gen10 12 G SAS Modular Controller

**Answer: D (LEAVE A REPLY)**

#### NEW QUESTION: 52

A customer needs a solution that supports rapid provisioning changes on physical bare-metal servers and on a virtualization hypervisor. They are considering migrating to a new solution that supports software-defined storage.

Which HPE compute platform should the customer implement?

- A. ProLiant DL
- B. Synergy
- C. SimpliVity
- D. BladeSystem

**Answer: B (LEAVE A REPLY)**

#### NEW QUESTION: 53

A fast-growing customer with a NAS-based storage solution is evaluating Fibre Channel storage for their VMware environment.

How would this customer benefit from adding 16 Gb Fibre Channel storage to their environment? (Choose two.)

- A. reduced latency
- B. increased simplicity

- C. increased performance
- D. simplified connectivity
- E. simplified administration

Answer: A,C ([LEAVE A REPLY](#))

**NEW QUESTION: 54**

Match the storage technology to the storage type.

Answer:

**NEW QUESTION: 55**

A customer just purchased a ProLiant 300 series Gen10 server and wants to install the latest version of Windows.

Which feature of this server will assist the customer with the initial Windows installation?

- A. Smart Storage Administrator
- B. HPE SmartStart
- C. Intelligent Provisioning
- D. HPE SSA Diagnostics

Answer: C ([LEAVE A REPLY](#))

**NEW QUESTION: 56**

HPE Support asks you to generate an SSD wear gauge report for local storage on an HPE DL360 Gen10 server running VMware.

Which procedure will ensure that the server will boot directly into a maintenance state so you can generate the requested report?

- A. Changing the one-time boot option to Smart Storage Administrator in iLO web-based user interface
- B. Use Always On functionality of Intelligent Provisioning
- C. Changing the one-time boot option to Intelligent Provisioning in iLO web-based user interface
- D. Click Boot to System Setup Utilities in iLO web-based user interface
- E. Changing the one-time boot option to Intelligent Provisioning in HPE OneView

**Answer: C (LEAVE A REPLY)**

Reference: [https://support.hpe.com/hpesc/public/docDisplay?docId=emr\\_na-a00051235en\\_us](https://support.hpe.com/hpesc/public/docDisplay?docId=emr_na-a00051235en_us)

**NEW QUESTION: 57**

You are validating a configuration prior to quoting it for the customer. You plan to propose the following configuration:

Two HPE DL380 Gen10 servers with dual processors, 256GB of memory, dual 10Gb NICs, SN1100Q

16Gb dual port FC HBA, dual 800W power supplies, and high temperature fan kit HPE Nimble HF20H with 11TB storage, 960GB of cache, dual port 10GbE NIC, and 16Gb dual port FC adapter kit Two SN3000B FC Switches Which tool should you use to verify firmware compatibility between the storage and server components in this proposed solution?

- A. HPE SPOCK
- B. HPE OneView Advanced
- C. HPE NinjaSTARS
- D. HPE One Configuration Advanced

**Answer: A (LEAVE A REPLY)**

**NEW QUESTION: 58**

Indicate whether each management feature manages or monitors a single system or multiple systems.

**Answer Area**



**Answer:  
Answer Area**

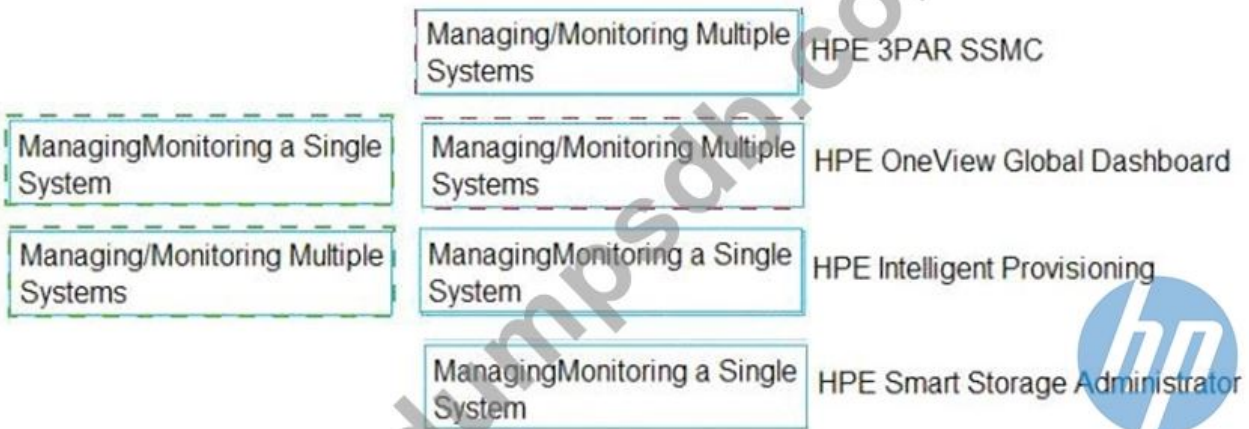

**Explanation**

- Multi
- Multi
- Single
- Single

**NEW QUESTION: 59**

You plan to install an HPE ProLiant DL360 Gen10 in an environment with an ambient temperature of 45 °C (113 °F).



Which additional option is required?

- A. M.2 Solid State Enablement Kit
- B. 500W Flex Slot Platinum PS Kit
- C. Gen10 Bezel Kit
- D. High Performance Fan Kit



**Answer: D (LEAVE A REPLY)**

**NEW QUESTION: 60**

Match the speed and protocol with the appropriate component.

Component		Speed and Protocol
SFP+		10GbE
QSFP28		12Gb SAS
Mini-SAS HD 4x		100GbE

Answer:

Component		Speed and Protocol
		10GbE
		12Gb SAS
		100GbE

Reference:

<https://buy.hpe.com/us/en/options/transceivers/server-transceivers/hpe-sfp-transceivers/p/7263510> [https://itg.buy.hpe.com/emea\\_europe/en/options/transceivers/server-transceivers/server-transceivers/hpe-qsfp28-transceivers/p/1008789459](https://itg.buy.hpe.com/emea_europe/en/options/transceivers/server-transceivers/server-transceivers/hpe-qsfp28-transceivers/p/1008789459)

**NEW QUESTION: 61**

Refer to the exhibit.

A Customer Nimble Storage Array

Summary: This is a single solution configuration.

Components: BOM Details for A Customer Nimble Storage Array

Layout: Expand All Collapse All Export Excel CLIC and Power Check BOM diff

+/-	Quantity	Product #	Product Description
-	1	Q8H39A	HPE Nimble Storage HF40 Adaptive Dual Controller 10GBASE-T 2-port Configure-to-order Base Array
+	1	Q8G27B	HPE Nimble Storage NOS Default FIO Software
+	1	Q8H45A	HPE Nimble Storage HF40/60 Adaptive Array 42 TB (21x2TB) FIO HDD Bundle
+	1	Q8H50A	HPE Nimble Storage HF40 Adaptive Array R2 2.88TB (6x480GB) FIO Cache Bundle
+	2	Q8J14A	HPE Nimble Storage C19 to C20 250V 16Amp 1.8m PDU Base Array FIO Power Cord
+	1	R3P91A	HPE NS AF/HF OEM Trk

Item/Subitem	Severity	Product Number	Rule number
0100/01	Unbuildable	Q8H39A	81125348
0100/01	Unbuildable	Q8H39A	81330046
0100/01	Warning	Q8H39A	81330047

**Advice Text**

Product#: Q8H39A Rule#: 81125348 Item/Subitem: 0100/01  
 UNBUILDABLE CONFIGURATION: OVERRIDE REQUIRES FACTORY APPROVAL  
 When ordering Q8H39A - HPE Nimble Storage HF40 Adaptive Dual Co.  
 minimum and maximum 1 quantity of the following Networking Adapters must be ordered.

- Q8B83B FIO HPE NS Embedded 10GBASE-T 2p FIO Adptr
- Q8B84B FIO HPE Nimble Storage 2x1GbE 2-port FIO Adapter Kit
- Q8B85B FIO HPE Nimble Storage 4x1GbE 2-port FIO Adapter Kit
- Q8B86B FIO HPE Nimble Storage 2x10GBASE-T 2-port FIO Adapter Kit
- Q8B87B FIO HPE Nimble Storage 4x10GBASE-T 2-port FIO Adapter Kit
- Q8B88B FIO HPE Nimble Storage 4x10GbE 2-port FIO Adapter Kit

Download Advice Done

**Power Check**

Appliance	Severity	Required Power	Provided Power
There are no products with Power Supply selections availables.			

You are validating a Nimble HF40 configuration created in OCA, and you receive an error when you run a CLIC check.

Which Nimble component needs to be added to the configuration to complete the solution?

- A. HPE Nimble Storage HF40/60 Adaptive ES3 21TB HDD 1.44 TB Cache CTO Expansion Shelf
- B. HPE Nimble Storage C19 to C20 250V 16 Amp 1.8m PDU Base Array FIO Power Cord
- C. HPE Nimble Storage Embedded 10GBASE-T 2-port FIO Adapter
- D. HPE Nimble Storage HF40 Adaptive Array R2 2.88 TB FIO Cache Bundle

**Answer: A (LEAVE A REPLY)**

**Valid HPE0-V14 Dumps** shared by TrainingQuiz.com for Helping Passing HPE0-V14 Exam! TrainingQuiz.com now offer the **newest HPE0-V14 exam dumps**, the TrainingQuiz.com HPE0-V14 exam **questions have been updated** and **answers have been corrected** get the **newest** TrainingQuiz.com HPE0-V14 dumps with Test Engine here:

Special Discount: **Exam-Tests**)

**NEW QUESTION: 62**

A customer requires five HPE ProLiant servers that will be mounted in a rack and shipped from site to site. All servers must be online within an hour of site arrival. Which feature will ensure that the servers will be available to the business if travel motion has damaged a DIMM?

- A. HPE Active Health System integration
- B. Triple+ Parity RAID protection
- C. Flash Back Write Cache battery protection
- D. HPE Fast Fault Tolerance Memory protection

Answer: ([SHOW ANSWER](#))

**NEW QUESTION: 63**

What is used to identify a storage HBA port in a Fibre Channel SAN fabric?

- A. ION
- B. SCSI ID
- C. MAC Address
- D. WWN

Answer: D ([LEAVE A REPLY](#))

**NEW QUESTION: 64**

You are validating a configuration prior to quoting it for the customer. You plan to propose the following configuration:

- \* Two HPE DL380 Gen10 servers with dual processors, 256GB of memory, dual 10Gb NICs, SN1100Q 16Gb dual port FC HBA, dual 800W power supplies, and high temperature fan kit
- \* HPE Nimble HF20H with 11TB storage, 960GB of cache, dual port 10GbE NIC, and 16Gb dual port FC adapter kit
- \* Two SN3000B FC Switches

Which tool should you use to verify firmware compatibility between the storage and server components in this proposed solution?

- A. HPE One Configuration Advanced
- B. HPE SPOCK
- C. HPE OneView Advanced
- D. HPE NinjaSTARS

Answer: B ([LEAVE A REPLY](#))

**NEW QUESTION: 65**

A customer is expanding from local storage to a SAN environment for the first time. They plan to future proof their environment with a 16 Gb Fibre Channel. They also want to allow for future I/O expansion with new servers.

Identify the correct server and storage to meet the customer requirements.

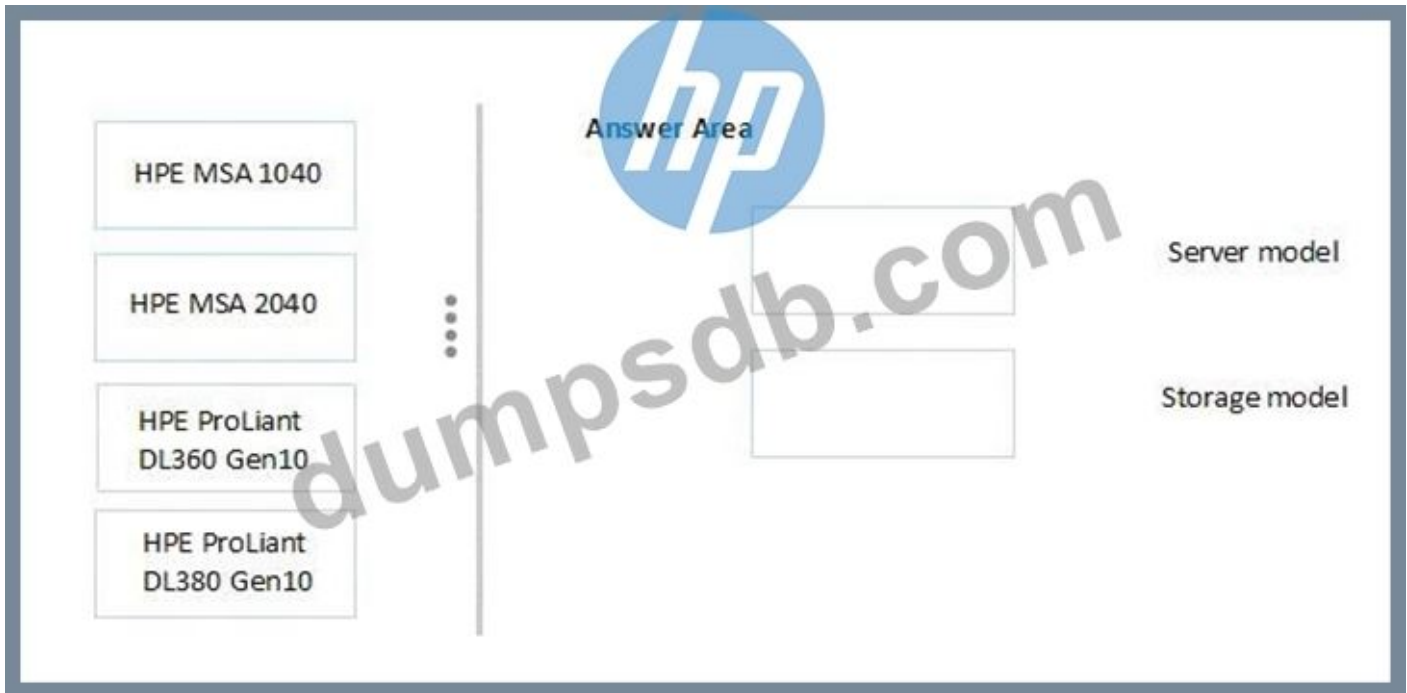

**Answer:**

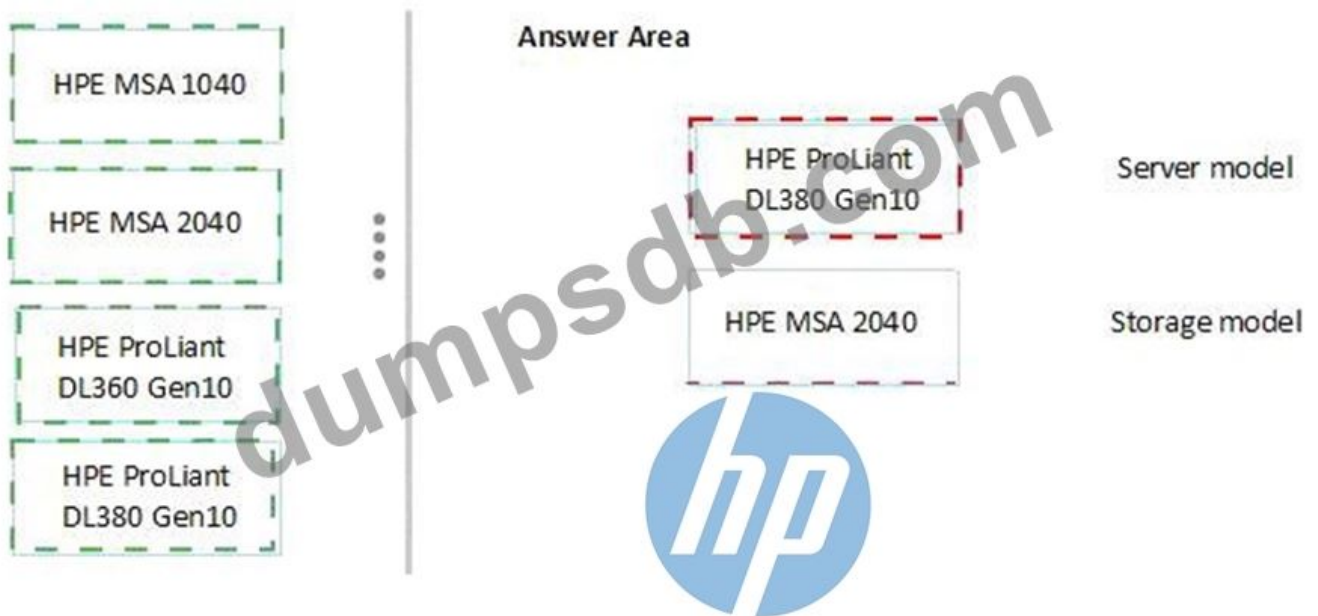

Explanation

Server model - HPE ProLiant DL380 Gen10

Storage model - HPE MSA 2040

**NEW QUESTION: 66**

A customer needs NFS access on a fiber channel array.

What must be included in the solution to meet this requirement?

- A. StoreEver
- B. Storage File Controller
- C. Smart Array Controller

D. StoreOnce RMC

**Answer: B (LEAVE A REPLY)**

Reference: <https://h20195.www2.hpe.com/v2/gethtml.aspx?docname=a00047729enw>

**NEW QUESTION: 67**

A customer requires a storage platform for their department data. They have a limited budget and will be sharing files among their Microsoft Windows environment.

Which HPE storage platform meets the customer's needs?

- A. StoreEasy
- B. StoreOnce
- C. 3PAR StoreServ
- D. Nimble

**Answer: (SHOW ANSWER)**

**NEW QUESTION: 68**

A customer needs NFS access on a fiber channel array.

What must be included in the solution to meet this requirement?

- A. StoreEver
- B. Storage File Controller
- C. Smart Array Controller
- D. StoreOnce RMC

**Answer: (SHOW ANSWER)**

Explanation/Reference: <https://h20195.www2.hpe.com/v2/gethtml.aspx?docname=a00047729enw>

**NEW QUESTION: 69**

An HPE customer wants to perform a simplified update of firmware and drivers among their 100 HPE Gen9 and Gen10 racked servers.

Which HPE software tool should the customer use to minimize the time required to perform this activity.

- A. HPE Smart Update Manager
- B. HPE OneView Standard
- C. HPE ProLiant Support Pack
- D. HPE iLO Amplifier Pack

**Answer: (SHOW ANSWER)**

Reference: <https://www.hpe.com/us/en/servers/smart-update.html>

**NEW QUESTION: 70**

What is the correct cable type to use when connecting a pair of switches using Long Range (LR) Transceivers?

- A. Direct Attach Cable (DAC)

- B. Twin-Ax
- C. Single Mode Fiber
- D. Multi-mode Fiber

**Answer: C (LEAVE A REPLY)**

Single-mode uses a single relatively straight beam of light, transmitted directly through a core of glass (or occasionally plastic) that's usually 50 microns across. Single-mode accommodates large power levels, and is almost exclusively used for Long Range (LR) applications.

Reference: <https://info.hummingbirdnetworks.com/blog/answering-your-frequently-asked-questions-about-different-types-of-10-gigabit-cisco-sfp-units>

#### **NEW QUESTION: 71**

A customer needs a virtual desktop infrastructure environment to quickly deploy new desktop images to more than 70 onsite contractors. They plan to use HPE ProLiant DL360 Gen10 servers running VMware ESXi connected to a shared storage device. The customer requires deduplication because they are concerned about the required storage capacity for the full clone images.

Which storage device would best address their concerns?

- A. HPE MSA 1040
- B. HPE MSA 2052
- C. HPE Nimble AF20
- D. HPE Nimble HF20C

**Answer: (SHOW ANSWER)**

Reference: [https://h20628.www2.hp.com/km-ext/kmcsdirect/emr\\_na-a00050816en\\_us-5.pdf](https://h20628.www2.hp.com/km-ext/kmcsdirect/emr_na-a00050816en_us-5.pdf)

#### **NEW QUESTION: 72**

Refer to the exhibit.

**Processor Option Kits (Required Processor)**

**2<sup>nd</sup> Generation Intel Xeon-Platinum**

HPE DL380 Gen10 Intel Xeon-Platinum 8280M (2.7GHz/28-core/205W) FIO Processor Kit

**NOTE:** Ships with Performance Heatsink

HPE DL380 Gen10 Intel Xeon-Platinum 8280L (2.7GHz/28-core/205W) FIO Processor Kit

**NOTE:** Ships with Performance Heatsink

HPE DL380 Gen10 Intel Xeon-Platinum 8280 (2.7GHz/28-core/205W) FIO Processor Kit

**NOTE:** Ships with Performance Heatsink

HPE DL380 Gen10 Intel Xeon-Platinum 8276M (2.2GHz/28-core/165W) FIO Processor Kit

**NOTE:** Ships with Performance Heatsink

HPE DL380 Gen10 Intel Xeon-Platinum 8276L (2.2GHz/28-core/165W) FIO Processor Kit

**NOTE:** Ships with Performance Heatsink

HPE DL380 Gen10 Intel Xeon-Platinum 8276 (2.2GHz/28-core/165W) FIO Processor Kit

**NOTE:** Ships with Performance Heatsink

HPE DL380 Gen10 Intel Xeon-Platinum 8270 (2.7GHz/26-core/205W) FIO Processor Kit

**NOTE:** Ships with Performance Heatsink

HPE DL380 Gen10 Intel Xeon-Platinum 8268 (2.9GHz/24-core/205W) FIO Processor Kit

**NOTE:** Ships with Performance Heatsink

HPE DL380 Gen10 Intel Xeon-Platinum 8260Y (2.4GHz/24-20-16-core/165W) FIO Processor Kit

**NOTE:** Ships with Performance Heatsink

HPE DL380 Gen10 Intel Xeon-Platinum 8260M (2.4GHz/24-core/165W) FIO Processor Kit

**NOTE:** Ships with Performance Heatsink

HPE DL380 Gen10 Intel Xeon-Platinum 8260L (2.4GHz/24-core/165W) FIO Processor Kit

**NOTE:** Ships with Performance Heatsink

HPE DL380 Gen10 Intel Xeon-Platinum 8260 (2.4GHz/24-core/165W) FIO Processor Kit

**NOTE:** Ships with Performance Heatsink

HPE DL380 Gen10 Intel Xeon-Platinum 8256 (3.8GHz/4-core/105W) FIO Processor Kit

**NOTE:** Ships with Performance Heatsink

HPE DL380 Gen10 Intel Xeon-Platinum 8253 (2.2GHz/16-core/125W) FIO Processor Kit

**1<sup>st</sup> Generation Intel Xeon-Platinum**

HPE DL380 Gen10 Intel Xeon-Platinum 8180M (2.5GHz/28-core/205W) FIO Processor Kit

A customer has two HPE ProLiant DL380 Gen10 servers running as an Oracle cluster. They are trying to reduce licensing costs and want to move to the best processor available from the list to minimize licensing costs while still providing a high level of performance for the Oracle database. Which DL380 Gen10 processor would you recommend?

- A. Intel Xeon-Platinum 8280M
- B. Intel Xeon-Platinum 8280
- C. Intel Xeon-Platinum 8256
- D. Intel Xeon-Platinum 8253

**Answer: D (LEAVE A REPLY)**

Explanation/Reference:

### NEW QUESTION: 73

Why is RAID 6 the best option for a large RAID set for archive storage on large-capacity drives?

- A. to maximize capacity of the volume
- B. to reduce risk during volume rebuild
- C. to reduce drive wear
- D. to increase write performance on the volume

**Answer: (SHOW ANSWER)**

### NEW QUESTION: 74

Refer to the exhibit.

Qty	Product Description
1	HPE StoreOnce 3620 24TB System
1	HPE StoreOnce Encryption E-LTU
1	HPE 3Y Foundation Care 24x7 SVC
1	HPE StoreOnce 3620 24TB System Support

A customer has been using VEEAM and the HPE StoreOnce 3620 shown in the exhibit to backup their environment. The customer's legal team has asked to double their retention times for all backup sets, and they are starting to run out of space on the StoreOnce.

Which options could you recommend that the customer add to their existing configuration to accommodate the new requirement? (Select two. Each option represents a separate solution.)

- A. HPE StoreOnce Cloud Bank Storage
- B. HPE StoreOnce 3620 24TB Capacity Upgrade Kit
- C. HPE StoreOnce Gen4 16Gb Fibre Channel Network Card
- D. HPE StoreOnce Gen4 10/25Gb SFP Network card
- E. HPE D3710 Storage Enclosure

**Answer: B,D (LEAVE A REPLY)**

Reference:

<https://www.hpe.com/uk/en/product-catalog/storage/disk-based-backup-systems/pip.specifications.hpe-storeonce-systems.1011014655.html>

### NEW QUESTION: 75

A customer plans to purchase five HPE DL380 Gb 2-port 530SFP Ethernet Adapters. The customer's network administrator has installed a top of rack 10 GbE switch capable of supporting copper and optical connections.

The customer is already over budget and needs to keep costs down.

Which option should you recommend for connecting to the switch?

- A. 3m Cat 6A Copper Cables
- B. 3m OM2 Fiber optic cables
- C. 3m Direct Attached Copper Cables
- D. 3m OM3 Fiber Optic Cables

**Answer: C** ([LEAVE A REPLY](#))

### NEW QUESTION: 76

A solution integrator is installing new equipment to the rack.

Click the recommended location for HPE R/T3000 Extended Runtime Module.

Hot Area:



**Answer:**



Answer is below rack 1 to 2 U UPS

**Valid HPE0-V14 Dumps** shared by TrainingQuiz.com for Helping Passing HPE0-V14 Exam! TrainingQuiz.com now offer the **newest HPE0-V14 exam dumps**, the TrainingQuiz.com HPE0-V14 exam **questions have been updated** and **answers have been corrected** get the **newest** TrainingQuiz.com HPE0-V14 dumps with Test Engine here:

<https://www.trainingquiz.com/HPE0-V14-practice-quiz.html> (305 Q&As Dumps, **40%OFF**

**Special Discount: Exam-Tests**)

**NEW QUESTION: 77**

Match the storage technology to the storage type.

Block	⋮	Answer Area	Technology	Type
File				
				iSCSI
				CIFS
				SAN
				NFS

**Answer:**

Block	⋮	Answer Area	Technology	Type
File				
			Block	iSCSI
			File	CIFS
			Block	SAN
			File	NFS

**NEW QUESTION: 78**

What is an access port on an Ethernet switch?

- A. A port that carries FCP frames inside the network
- B. A port that carries multiple VLANs
- C. A port that is connected to an FCF
- D. A port that carries untagged frames inside the network

**Answer: D (LEAVE A REPLY)**

Explanation/Reference: [https://support.hpe.com/hpesc/public/docDisplay?docId=mmr\\_kc-0102233](https://support.hpe.com/hpesc/public/docDisplay?docId=mmr_kc-0102233)

**NEW QUESTION: 79**

A customer is planning to deploy a branch office server rack. The environment will have the following requirements:

- \* Single rack with 20 HPE ProLiant DL360 Gen10 Servers.
- \* Each Server will have 6 x 10G SFP+ Ports.
- \* Each Server will have a dedicated iLO port.

- \* The customer requires that only two switches be used.
- \* The customer requires separate control planes.

Which switch configuration can meet these requirements?

- A. 2 X Aruba 8325 Series switches with VSX
- B. 2 X HPE 5945 Series switch with IRF
- C. 2 X Aruba 8325 Series switches with backplane stacking.
- D. 2 X HPE 5945 Series switches standalone

**Answer: D (LEAVE A REPLY)**

**NEW QUESTION: 80**

Match each HPE solution to its corresponding technology usage.

HPE Solution		Usage
HPE OneView Advanced	<input type="text"/>	single-pane management and monitoring for selected HPE devices
HPE ProLiant	<input type="text"/>	industry-leading server platform for a broad range of workloads
HPE Simplivity	<input type="text"/>	purpose-built hyperconverged solution

**Answer:**

HPE Solution		Usage
HPE OneView Advanced	HPE OneView Advanced	single-pane management and monitoring for selected HPE devices
HPE ProLiant	HPE ProLiant	industry-leading server platform for a broad range of workloads
HPE Simplivity	HPE Simplivity	purpose-built hyperconverged solution

Explanation

## Answer Area

### HPE Solution

### Usage

HPE OneView  
Advanced

HPE OneView  
Advanced

single-pane management and monitoring  
for selected HPE devices

HPE ProLiant

HPE ProLiant

industry-leading server platform for a broad  
range of workloads

HPE Simplivity

HPE Simplivity

purpose-built hyperconverged solution

### NEW QUESTION: 81

You need to create a dynamic bridge-aggregation group on a FlexFabric switch to ensure the ports are automatically configured with the applicable bridge-aggregation interface configuration. Drag the steps on the left into their appropriate order in the answer area on the right.

### Answer:

### NEW QUESTION: 82

You are designing a system for a customer that has a contract with a government agency. The contract requires the highest level of security algorithms possible.

Which HPE ProLiant Gen10 feature set will address this customer's needs?

- A. CNSA mode
- B. FIPS 140-2 mode
- C. high security mode

D. production mode

Answer: ([SHOW ANSWER](#))

**NEW QUESTION: 83**

Match each characteristic to the correct storage type.

**Answer Area**

DL

ML

maximum 2 processors

maximum 4 processors

rack optimized

tower or rack

Answer:

**Answer Area**

ML

DL

DL

ML

ML

maximum 2 processors

maximum 4 processors

rack optimized

tower or rack

Explanation

ML / DL / DL / ML

Reference:

<https://www.hpe.com/uk/en/product-catalog/servers/proliant-servers/pip.specifications.hpe-proliant-dl380-gen10-server.1010026818.html>

**NEW QUESTION: 84**

You are configuring an MSA 2052 for one of your customers in OCA.

Click on either one of the two places on the Bill of Materials screen that will enable you to verify the configuration and get details on any errors

The screenshot shows the HP One Config interface. At the top, there is a navigation bar with the following items: **Advanced One Config**, **New Configuration**, **Open Configurations**, **Manage MyLibrary**, **Import**, and **Useful Link**. Below the navigation bar, there are icons for **Save**, **Export**, **Catalog**, and **New Delegation**.

The main content area is titled **A Customer MSA 2052**. It contains a summary section stating "This is a single solution configuration." and a section for **BOM Details for A Customer MSA 2052**. There are two buttons: **Expand All** and **Collapse All**.

On the left side, there is a sidebar with the following menu items: **Summary**, **Components**, **Layout**, **Power**, **BOM** (highlighted), **Customer Intent**, and **Services**.

The BOM table has the following columns: **Quantity**, **Product #**, and **Product Description**. The table contains the following data:

Quantity	Product #	Product Description
1	Q1J03A	HPE MSA 2052 SAN
22	J9F49A	HPE MSA 1.8TB 12G S
22	J9F49A OD1	Factory Integrated
3	Q1J06A	HPE MSA 2050 LFF I
3	Q1J06A OD1	Factory Integrated
36	M0S90A	HPE MSA 8TB 12G S
36	M0S90A OD1	Factory Integrated

**Answer:**

Advanced One Config [New Configuration](#) [Open Configurations](#) [Manage MyLibrary](#) [Import](#) [Useful Links](#)

Save Export Catalog New Delegation

A Customer MSA 2052

Summary  
Components  
Layout  
Power  
BOM  
Customer Intent  
Services

This is a single solution configuration.  
BOM Details for A Customer MSA 2052

Expand All Collapse All

+/-	Quantity	Product #	Product Description
-	1	Q1J03A	HPE MSA 2052 SAN D
-	22	J9F49A	HPE MSA 1.8TB 12G S
-	22	J9F49A OD1	Factory Integrated
-	3	Q1J06A	HPE MSA 2050 LFF D
-	3	Q1J06A OD1	Factory Integrated
-	36	M0S90A	HPE MSA 8TB 12G SA
-	36	M0S90A OD1	Factory Integrated

**NEW QUESTION: 85**

Match the storage technology to the storage type.

Block  
File

Answer Area

Technology	Type
<input type="text"/>	iSCSI
<input type="text"/>	CIFS
<input type="text"/>	SAN
<input type="text"/>	NFS

Answer:

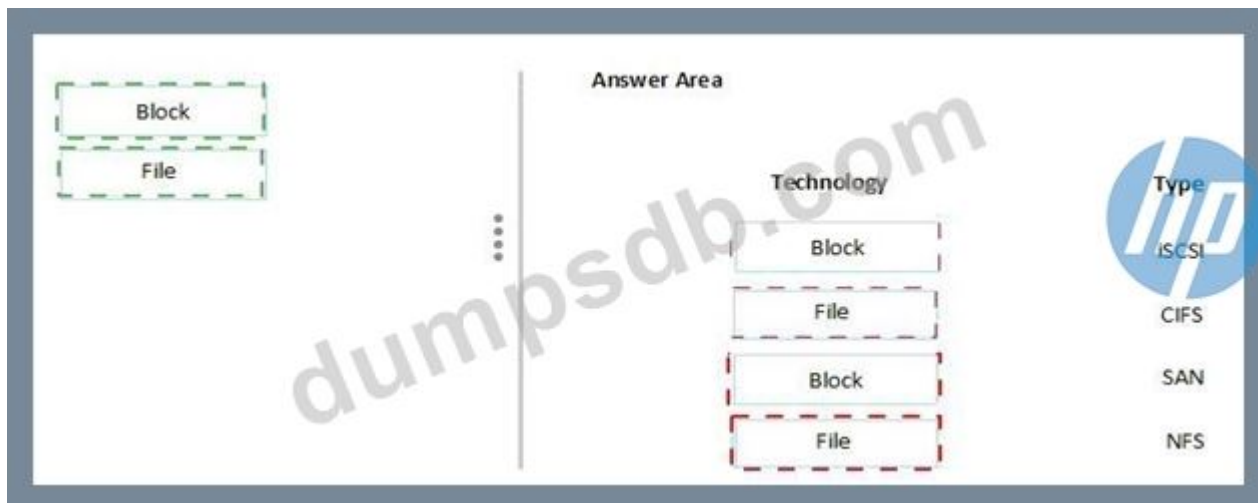

Explanation

BLOCK = iSCSI

File = CIFS

BLOCK = SAN

File = NFS

### NEW QUESTION: 86

You have configured a port on an HPE FlexFabric 5900 series switch that is connected to a VMware ESXi server to support multiple VLANs.

```
interface Ten-GigabitEthernet 1/0/11 description server ESXi01 -eth1 port link-type trunk
port trunk permit vlan 50 port trunk permit vlan 2 port trunk pvid vlan 50
```

Given the configuration above, what should happen to any of the untagged traffic coming from the VMware ESXi host?

- A. The untagged traffic will be transmitted in vlan 50.
- B. The untagged traffic will be transmitted in vlan 1.
- C. The untagged traffic will be transmitted in vlan 2.
- D. The untagged traffic will be dropped.

Answer: A ([LEAVE A REPLY](#))

### NEW QUESTION: 87

Match each adapter to its characteristic.

**Answer Area**

Adapter		Characteristic
FlexLOM		provide RAID configuration using disks internal to the server
FlexFabric		allow choice of network interface on the motherboard
Smart Array		connect to native Fibre Channel SAN with a PCIe adapter
HBA		connect to a Fibre Channel over Ethernet (FCoE) SAN environment with a PCIe adapter

**Answer:**

**Answer Area**



Adapter		Characteristic
FlexLOM	Smart Array	provide RAID configuration using disks internal to the server
FlexFabric	FlexLOM	allow choice of network interface on the motherboard
Smart Array	HBA	connect to native Fibre Channel SAN with a PCIe adapter
HBA	FlexFabric	connect to a Fibre Channel over Ethernet (FCoE) SAN environment with a PCIe adapter

**Explanation**

**Answer Area**



Adapter		Characteristic
FlexLOM	Smart Array	provide RAID configuration using disks internal to the server
FlexFabric	FlexLOM	allow choice of network interface on the motherboard
Smart Array	HBA	connect to native Fibre Channel SAN with a PCIe adapter
HBA	FlexFabric	connect to a Fibre Channel over Ethernet (FCoE) SAN environment with a PCIe adapter

**NEW QUESTION: 88**

HPE Support asks you to generate an SSD wear gauge report for local storage on an HPE DL360 Gen10 server running VMware.

Which procedure will ensure that the server will boot directly into a maintenance state so you can generate the requested report?

- A. Changing the one-time boot option to Smart Storage Administrator in iLO web-based user interface
- B. Use Always On functionality of Intelligent Provisioning
- C. Changing the one-time boot option to Intelligent Provisioning in iLO web-based user interface
- D. Click Boot to System Setup Utilities in iLO web-based user interface
- E. Changing the one-time boot option to Intelligent Provisioning in HPE OneView

**Answer: A (LEAVE A REPLY)**

Explanation/Reference: [https://support.hpe.com/hpesc/public/docDisplay?docId=emr\\_na-a00051235en\\_us](https://support.hpe.com/hpesc/public/docDisplay?docId=emr_na-a00051235en_us)

### NEW QUESTION: 89

Refer to the exhibit.



You observed some high temperature alerts on a switch shown in the middle rack of the exhibit. The cooling in the data center is following best practices for the layout in the exhibit. The switch is an HPE 5945 series switch, and all the fans are operating normally. The switch is racked so that its ports face the rear of the rack. The administrator noticed the fan modules have red handles.

What should the administrator do to resolve the issue?

- A. Replace the fan modules with port-to-power fan modules.
- B. Change the fan direction with the fan preferred direction command.
- C. Replace the fan modules with power-to-port fan modules.

D. Add additional fan modules to the switch.

Answer: B ([LEAVE A REPLY](#))

### NEW QUESTION: 90

Refer to the exhibit.

Qty	Product Description
1	HPE StoreOnce 3620 24TB System
1	HPE StoreOnce Encryption E-LTU
1	HPE 3Y Foundation Care 24x7 SVC
1	HPE StoreOnce 3620 24TB System Support

A customer has been using VEEAM and the HPE StoreOnce 3620 shown in the exhibit to backup their environment. The customer's legal team has asked to double their retention times for all backup sets, and they are starting to run out of space on the StoreOnce.

Which options could you recommend that the customer add to their existing configuration to accommodate the new requirement? (Select two. Each option represents a separate solution.)

- A. HPE StoreOnce Cloud Bank Storage
- B. HPE StoreOnce 3620 24TB Capacity Upgrade Kit
- C. HPE StoreOnce Gen4 16Gb Fibre Channel Network Card
- D. HPE StoreOnce Gen4 10/25Gb SFP Network card
- E. HPE D3710 Storage Enclosure

Answer: A,B ([LEAVE A REPLY](#))

Reference: <https://www.hpe.com/uk/en/product-catalog/storage/disk-based-backup-systems/pip.specifications.hpe-storeonce-systems.1011014655.html>

### NEW QUESTION: 91

You need to review a warning on a Nimble storage array.

Click on the menu option that displays this information.



Answer:



Explanation



Reference: [https://infosight.hpe.com/InfoSight/media/cms/active/public/pubs\\_GUI\\_Administration\\_Guide\\_NOS\\_50x.whz/axc1501525262696.html](https://infosight.hpe.com/InfoSight/media/cms/active/public/pubs_GUI_Administration_Guide_NOS_50x.whz/axc1501525262696.html)

**Valid HPE0-V14 Dumps** shared by TrainingQuiz.com for Helping Passing HPE0-V14 Exam! TrainingQuiz.com now offer the **newest HPE0-V14 exam dumps**, the TrainingQuiz.com HPE0-V14 exam **questions have been updated** and **answers have been corrected** get the **newest** TrainingQuiz.com HPE0-V14 dumps with Test Engine here:

<https://www.trainingquiz.com/HPE0-V14-practice-quiz.html> (305 Q&As Dumps, **40%OFF**

**Special Discount: Exam-Tests**)

#### NEW QUESTION: 92

A customer is planning to deploy a new Top of Rack solution. They plan to use a stacking technology that meets the following requirements:

- \* Support for Multi Chassis Link Aggregation in an active-active mode.
- \* The control plane must not be a single point of failure.

- \* Rapid Fail-over. Unified Management.
- \* They require a maximum of two switches per stack.

Which stacking technology meets the customer's requirements?

- A. HPE Intelligent Resilient Framework (IRF)
- B. HPE Distributed Trunking
- C. Aruba Virtual Switching Extension (VSX)
- D. Aruba Virtual Switching Framework (VSF)

**Answer: C (LEAVE A REPLY)**

Reference:

[https://www.arubanetworks.com/assets/tg/AVD\\_Midsize-Campus-Design-Deploy.pdf](https://www.arubanetworks.com/assets/tg/AVD_Midsize-Campus-Design-Deploy.pdf)

**NEW QUESTION: 93**

A customer purchased a Nimble HF20 a year ago They are experiencing an issue with a few of their VMware servers in the RTP Nimble date center and asked that you make a recommendation based on the data in infoSight.

NAME	VOLUME	ARRAY	TYPE (VER...)	BLOCK SIZE	USAGE
Datastore3-VM-sync-snaps			VMFS (6.81)	1 MiB	37.0% (75)
VMware-DS-1-VMFS6			VMFS (6.81)	1 MiB	46.3% (94)
VMware-DS-2			VMFS (6.81)	1 MiB	56.9% (11)
Vmware-DS-3			VMFS (5.81)	1 MiB	52.5% (10)
VMware-DS-5			VMFS (6.81)	1 MiB	42.1% (21)
VMware-DS-6-Limit			VMFS (5.81)	1 MiB	3.8% (73.5)
VMware-DS-7-Space			VMFS (6.81)	1 MiB	0.1% (1.4)
VMware-DS-8-Exchange			VMFS (5.81)	1 MiB	3.4% (59.2)
VMware-DS-9-Space-NoDeDup			VMFS (5.81)	1 MiB	94.9% (18)
VMvol			VMVOL	0 B	0.0% (0.0)

What should you recommend'?

- A. Add another datastore for the RTP Nimble Datacenter

- B. increase the cache size for VMware-DS-Space-NoDeDup
- C. increase the datastore size for VMware-DS-Space-NoDeDup.
- D. Add cache to the array for the RTP Nimble Datacenter.

**Answer: A ([LEAVE A REPLY](#))**

#### **NEW QUESTION: 94**

A customer requires five HPE ProLiant servers that will be mounted in a rack and shipped from site to site. All servers must be online within an hour of site arrival. Which feature will ensure that the servers will be available to the business if travel motion has damaged a DIMM?

- A. Flash Back Write Cache battery protection
- B. HPE Fast Fault Tolerance Memory protection
- C. Triple+ Parity RAID protection
- D. HPE Active Health System integration

**Answer: A ([LEAVE A REPLY](#))**

#### **NEW QUESTION: 95**

What is an access port on an Ethernet switch?

- A. A port that carries FCP frames inside the network
- B. A port that carries untagged frames inside the network
- C. A port that is connected to an FCF
- D. A port that carries multiple VLANs

**Answer: B ([LEAVE A REPLY](#))**

#### **NEW QUESTION: 96**

A solution Integrator is installing new equipment to the rack. Click the recommended location area for R3000 Gen5 UPS.



**Answer:**



**NEW QUESTION: 97**

What is an access port on an Ethernet switch?

- A. A port that carries FCP frames inside the network
- B. A port that carries multiple VLANs
- C. A port that is connected to an FCF
- D. A port that carries untagged frames inside the network

**Answer: D (LEAVE A REPLY)**

Reference:

[https://support.hpe.com/hpesc/public/docDisplay?docId=mmr\\_kc-0102233](https://support.hpe.com/hpesc/public/docDisplay?docId=mmr_kc-0102233)

**NEW QUESTION: 98**

Match each HPE solution to its optimal use case.

Select and Place:

**Answer Area**

HPE Solution		Use Case
HPE Proliant Microserver	<input type="text"/>	General Purpose Computing, Virtualization Clusters, Enterprise Applications
HPE Proliant ML/DL	<input type="text"/>	NAS Storage, File Sync and Share for Remote/Mobile users
HPE StoreEasy	<input type="text"/>	Remote Office, Low Cost, Quiet Operation, Office environment
HPE StoreOnce	<input type="text"/>	Space-efficient Backups, Backup Replication, Cloud-based Archiving

**Answer:**

Select and Place:

**Answer Area**

HPE Solution		Use Case
HPE Proliant Microserver	HPE Proliant ML/DL	General Purpose Computing, Virtualization Clusters, Enterprise Applications
HPE Proliant ML/DL	HPE StoreEasy	NAS Storage, File Sync and Share for Remote/Mobile users
HPE StoreEasy	HPE Proliant Microserver	Remote Office, Low Cost, Quiet Operation, Office environment
HPE StoreOnce	HPE StoreOnce	Space-efficient Backups, Backup Replication, Cloud-based Archiving



**NEW QUESTION: 99**

A customer has a single HPE ProLiant Gen 10 server.



Which embedded management tool should they use to monitor the server?

- A. HPE OneView Standard
- B. NPE Intelligent Provisioning
- C. HPE Smart Update Manager
- D. HPE iLO5

**Answer: C (LEAVE A REPLY)**

**NEW QUESTION: 100**

Match the speed and protocol with the appropriate component.

Component		Speed and Protocol
SFP+		10GbE
QSFP28		12Gb SAS
Mini-SAS HD 4x		100GbE

Answer:

Component		Speed and Protocol
SFP+	SFP+	10GbE
QSFP28	Mini-SAS HD 4x	12Gb SAS
Mini-SAS HD 4x	QSFP28	100GbE

Reference:

<https://buy.hpe.com/us/en/options/transceivers/server-transceivers/hpe-sfp-transceivers/p/7263510> [https://itg.buy.hpe.com/emea\\_europe/en/options/transceivers/server-transceivers/server-transceivers/hpe-qsfp28-transceivers/p/1008789459](https://itg.buy.hpe.com/emea_europe/en/options/transceivers/server-transceivers/server-transceivers/hpe-qsfp28-transceivers/p/1008789459)

**NEW QUESTION: 101**

Which HPE Proliant server should you recommend for a home office environment where the server will be located in the same office as the user?

- A. HPE ML110
- B. HPEXL170r
- C. HPE DL20
- D. HPE MicroServer

Answer: A ([LEAVE A REPLY](#))

**NEW QUESTION: 102**

Drag the correct protocols from the left to their appropriate area on the topology.



**Answer:**

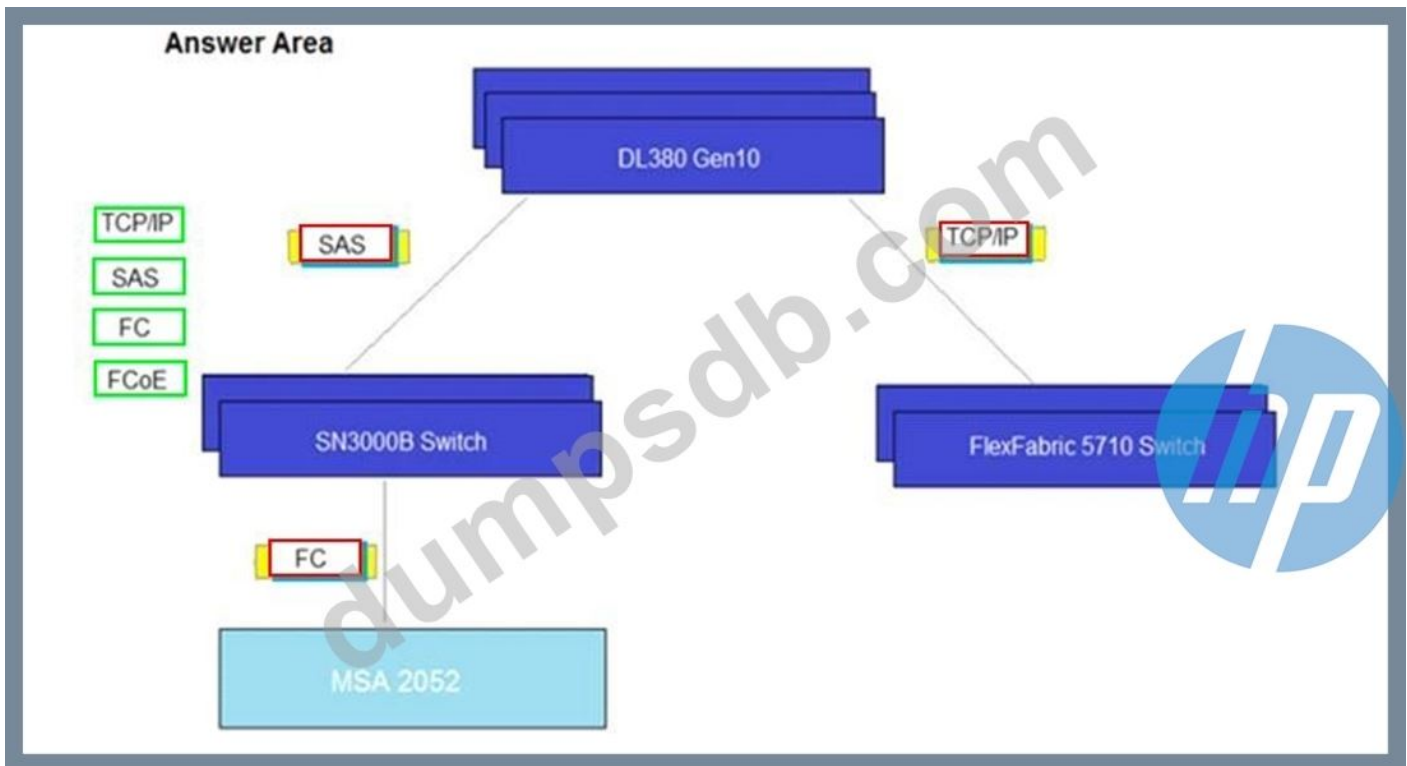

**NEW QUESTION: 103**

Read the question, and then refer to the exhibit.

```
<Switch-A>display interface Ten-GigabitEthernet 1/0/1
Ten-GigabitEthernet1/0/1 Current state:
Administratively DOWN Line protocol state: DOWN IP packet frame type: Ethernet II, hardware
address: d894-03fb-793d Description: Ten-GigabitEthernet1/0/1 Interface Bandwidth: 10000000
kbps Loopback is not set Media type is stack wire, port hardware type is STACK_SFP_PLUS
Unknown-speed mode, unknown-duplex mode Link speed type is autonegotiation, link duplex
```

type is autonegotiation Flow-control is not enabled Maximum frame length: 10000 Allow jumbo frames to pass Broadcast max-ratio: 100% Multicast max-ratio: 100% Unicast max-ratio: 100% PVID: 1 MDI type: Automdix Port link-type: Trunk VLAN Passing: 10, 20 VLAN permitted: 10, 20 Trunk port encapsulation: IEEE 802.1q Port priority: 0 Last link flapping: 0 hours 0 minutes 18 seconds Last clearing of counters: Never Peak input rate: 78 bytes/sec, at 2011-03-31 04:55:57 Peak output rate: 15 bytes/sec, at 2011-03-30 23:00:57 Last 300 second input: 0 packets/sec 67 bytes/sec - % Last 300 second output: 0 packets/sec 14 bytes/sec - % Input (total): 62670 packets, 8565340 bytes 0 unicasts, 0 broadcasts, 62670 multicasts, 0 pauses Input (normal): 62670 packets, - bytes 0 unicasts, 0 broadcasts, 62670 multicasts, 0 pauses Input: 0 input errors, 0 runts, 0 giants, 0 throttles 0 CRC, 0 frame, - overruns, 0 aborts - ignored, - parity errors Output (total): 3707 packets, 1294835 bytes 0 unicasts, 0 broadcasts, 3707 multicasts, 0 pauses Output (normal): 3707 packets, - bytes 0 unicasts, 0 broadcasts, 3707 multicasts, 0 pauses Output: 0 output errors, - underruns, - buffer failures 0 aborts, 0 deferred, 0 collisions, 0 late collisions 0 lost carrier, - no carrier A customer added a new switch to their network. They connected it using interface Ten-GigabitEthernet 1/0/1. They are using VLAN 10 and 20 for the devices in their network.

The new switch was fully operational. Then, the customer experienced a power failure later that day and could not reach any device on the new switch after the power returned.

From the output in the exhibit, would could be the issue?

- A. The interface link-speed and duplex are unknown.
- B. The interface is administratively down.
- C. The interface loopback is not set.
- D. The interface is configured for a PVID of VLAN 1.

**Answer: D ([LEAVE A REPLY](#))**

#### **NEW QUESTION: 104**

Refer to the exhibit.

**Processor Option Kits (Required Processor)**

**2<sup>nd</sup> Generation Intel Xeon-Platinum**

HPE DL380 Gen10 Intel Xeon-Platinum 8280M (2.7GHz/28-core/205W) FIO Processor Kit

**NOTE:** Ships with Performance Heatsink

HPE DL380 Gen10 Intel Xeon-Platinum 8280L (2.7GHz/28-core/205W) FIO Processor Kit

**NOTE:** Ships with Performance Heatsink

HPE DL380 Gen10 Intel Xeon-Platinum 8280 (2.7GHz/28-core/205W) FIO Processor Kit

**NOTE:** Ships with Performance Heatsink

HPE DL380 Gen10 Intel Xeon-Platinum 8276M (2.2GHz/28-core/165W) FIO Processor Kit

**NOTE:** Ships with Performance Heatsink

HPE DL380 Gen10 Intel Xeon-Platinum 8276L (2.2GHz/28-core/165W) FIO Processor Kit

**NOTE:** Ships with Performance Heatsink

HPE DL380 Gen10 Intel Xeon-Platinum 8276 (2.2GHz/28-core/165W) FIO Processor Kit

**NOTE:** Ships with Performance Heatsink

HPE DL380 Gen10 Intel Xeon-Platinum 8270 (2.7GHz/26-core/205W) FIO Processor Kit

**NOTE:** Ships with Performance Heatsink

HPE DL380 Gen10 Intel Xeon-Platinum 8268 (2.9GHz/24-core/205W) FIO Processor Kit

**NOTE:** Ships with Performance Heatsink

HPE DL380 Gen10 Intel Xeon-Platinum 8260Y (2.4GHz/24-20-16-core/165W) FIO Processor Kit

**NOTE:** Ships with Performance Heatsink

HPE DL380 Gen10 Intel Xeon-Platinum 8260M (2.4GHz/24-core/165W) FIO Processor Kit

**NOTE:** Ships with Performance Heatsink

HPE DL380 Gen10 Intel Xeon-Platinum 8260L (2.4GHz/24-core/165W) FIO Processor Kit

**NOTE:** Ships with Performance Heatsink

HPE DL380 Gen10 Intel Xeon-Platinum 8260 (2.4GHz/24-core/165W) FIO Processor Kit

**NOTE:** Ships with Performance Heatsink

HPE DL380 Gen10 Intel Xeon-Platinum 8256 (3.8GHz/4-core/105W) FIO Processor Kit

**NOTE:** Ships with Performance Heatsink

HPE DL380 Gen10 Intel Xeon-Platinum 8253 (2.2GHz/16-core/125W) FIO Processor Kit

**1<sup>st</sup> Generation Intel Xeon-Platinum**

HPE DL380 Gen10 Intel Xeon-Platinum 8180M (2.5GHz/28-core/205W) FIO Processor Kit

A customer has two HPE ProLiant DL380 Gen10 servers running as an Oracle cluster. They are trying to reduce licensing costs and want to move to the best processor available from the list to minimize licensing costs while still providing a high level of performance for the Oracle database. Which DL380 Gen10 processor would you recommend?

- A. Intel Xeon-Platinum 8256
- B. Intel Xeon-Platinum 8280M
- C. Intel Xeon-Platinum 8253
- D. Intel Xeon-Platinum 8280

Answer: A ([LEAVE A REPLY](#))

**NEW QUESTION: 105**

Match the stacking technology to the switch series.

<input type="text" value="IRF"/>	<b>Answer Area</b>	<input type="text"/>	ArubaOS-CX
<input type="text" value="VSF"/>		<input type="text"/>	FlexFabric
<input type="text" value="VSX"/>		<input type="text"/>	ArubaOS-Switch
		<input type="text"/>	FlexNetwork
		<input type="text"/>	

Answer:

<input type="text" value="IRF"/>	<b>Answer Area</b>	<input type="text" value="VSF"/>	ArubaOS-CX
<input type="text" value="VSF"/>		<input type="text" value="IRF"/>	FlexFabric
<input type="text" value="VSX"/>		<input type="text" value="VSF"/>	ArubaOS-Switch
		<input type="text" value="IRF"/>	FlexNetwork
		<input type="text"/>	

Reference:

<https://community.arubanetworks.com/community-home/digestviewer/viewthread?MID=25306>

[https://en.wikipedia.org/wiki/Intelligent\\_Resilient\\_Framework](https://en.wikipedia.org/wiki/Intelligent_Resilient_Framework)

**NEW QUESTION: 106**

A customer is planning to deploy a new Top of Rack solution. They plan to use a stacking technology that meets the following requirements:

- \* Support for Multi Chassis Link Aggregation in an active-active mode.
- \* The control plane must not be a single point of failure.
- \* Rapid Fail-over.
- \* Unified Management.
- \* They require a maximum of two switches per stack.

Which stacking technology meets the customer's requirements?

- A. HPE Intelligent Resilient Framework (IRF)
- B. HPE Distributed Trunking
- C. Aruba Virtual Switching Extension (VSX)
- D. Aruba Virtual Switching Framework (VSF)

**Answer: C ([LEAVE A REPLY](#))**

Explanation

Explanation/Reference: [https://www.arubanetworks.com/assets/tg/AVD\\_Midsize-Campus-Design-Deploy.pdf](https://www.arubanetworks.com/assets/tg/AVD_Midsize-Campus-Design-Deploy.pdf)

**Valid HPE0-V14 Dumps** shared by TrainingQuiz.com for Helping Passing HPE0-V14 Exam! TrainingQuiz.com now offer the **newest HPE0-V14 exam dumps**, the TrainingQuiz.com HPE0-V14 exam **questions have been updated** and **answers have been corrected** get the **newest** TrainingQuiz.com HPE0-V14 dumps with Test Engine here:

<https://www.trainingquiz.com/HPE0-V14-practice-quiz.html> (305 Q&As Dumps, **40%OFF**)

**Special Discount: [Exam-Tests](#))**

#### **NEW QUESTION: 107**

A security client needs a surveillance solution to support 239 Cameras. They expect to generate 2PB of data and require a 10Gb network infrastructure in a single rack.

Which solution should you recommend to meet the customer requirements?

- A. HPE Apollo Servers
- B. HPE SimpliVity 380
- C. HPE Moonshot
- D. HPE MSA

**Answer: A ([LEAVE A REPLY](#))**

#### **NEW QUESTION: 108**

You need to configure a HPE ProLiant server and plan to install an operating system that supports Secure Boot.

Which system utility should you use to configure the server?

- A. UEFI
- B. Intelligent Provisioning
- C. Smart Storage Administrator
- D. iLO

**Answer: A ([LEAVE A REPLY](#))**

#### **NEW QUESTION: 109**

An administrator has two switches connected with a single link. The administrator observes that, during hours of peak activity, the storage traffic tends to consume the link. The link is shared with other types of traffic that is time sensitive.

What technology can the administrator use to help alleviate the situation while they are working towards a long-term solution?

- A. Open Shortest Path First (OSPF)
- B. Priority-based Flow Control (PFC)
- C. RDMA over Converged Ethernet (RoCE)
- D. Multi Active Discriminator (MAD)

Answer: ([SHOW ANSWER](#))

**NEW QUESTION: 110**

Which component of HPE iLO provides continuous monitoring of more than 1600 parameters?

- A. Active Health System
- B. Insight Remote Support
- C. insight Diagnostics
- D. Silicon root of trust

Answer: A ([LEAVE A REPLY](#))

**NEW QUESTION: 111**

Match the speed and protocol with the appropriate component.

Component	Speed and Protocol
SFP+	10GbE
QSFP28	12Gb SAS
Mini-SAS HD 4x	100GbE

Answer:

Profile	Description
Mission Critical	Maximizes processor speed
Transactional Application Processing	Large number of database operations
General Peak Frequency Compute	Trades performance for reliability

Explanation

Component		Speed and Protocol
SFP+	SFP+	10GbE
QSFP28	Mini-SAS HD 4x	12Gb SAS
Mini-SAS HD 4x	QSFP28	100GbE

Reference:

<https://buy.hpe.com/us/en/options/transceivers/server-transceivers/hpe-sfp-transceivers/p/7263510>

[https://itg.buy.hpe.com/emea\\_europe/en/options/transceivers/server-transceivers/server-transceivers/hpe-qsfp28-transceivers/p/1008789459](https://itg.buy.hpe.com/emea_europe/en/options/transceivers/server-transceivers/server-transceivers/hpe-qsfp28-transceivers/p/1008789459)

### NEW QUESTION: 112

Match each adapter to its characteristic.

**Answer Area**

Adapter	Characteristic
FlexLOM	provide RAID configuration using disks internal to the server
FlexFabric	allow choice of network interface on the motherboard
Smart Array	connect to native Fibre Channel SAN with a PCIe adapter
HBA	connect to a Fibre Channel over Ethernet (FCoE) SAN environment with a PCIe adapter

Answer:

**Answer Area**

Adapter	Characteristic
FlexLOM	Smart Array provide RAID configuration using disks internal to the server
FlexFabric	FlexLOM allow choice of network interface on the motherboard
Smart Array	HBA connect to native Fibre Channel SAN with a PCIe adapter
HBA	FlexFabric connect to a Fibre Channel over Ethernet (FCoE) SAN environment with a PCIe adapter

**NEW QUESTION: 113**

A customer environment is being managed and monitored with HPE OneView. A review of the OneView log shows that there have been several trap storm events.

Which series of events must take place for OneView to insert a Trap Storm event entry into the log of system events?

- A. SNMP traps from three or more identical hosts have been logged within the past 256 seconds.
- B. Four or more identical SNMP traps have been logged within the past 30 seconds.
- C. Three or more SNMP trap messages have been logged with increasingly critical variable string values.
- D. Four or more ports on the same network switch have reported sequential SNMP trap messages

**Answer: C (LEAVE A REPLY)**

Explanation/Reference:

**NEW QUESTION: 114**

Match the feature to the lowest iLO5 license in which it is available

License	Feature
<input type="text"/>	Automatic Secure Recovery of firmware
<input type="text"/>	Common Access Card (CAC) 2-factor authentication
<input type="text"/>	Virtual Media
<input type="text"/>	Secure Erase of NAND Data: Sanitization of flash parts to ensure a pristine server configuration for redeployment

**Answer:**

License	Feature
HPE iLO Essentials	Automatic Secure Recovery of firmware
HPE iLO Advanced	Common Access Card (CAC) 2-factor authentication
HPE iLO Scale-Out	Virtual Media
HPE iLO Advanced Premium Security Edition	Secure Erase of NAND Data: Sanitization of flash parts to ensure a pristine server configuration for redeployment

Explanation

Last - last

3-2

1-1

3-3

**NEW QUESTION: 115**

Match the characteristic to the correct HPE ProLiant family.

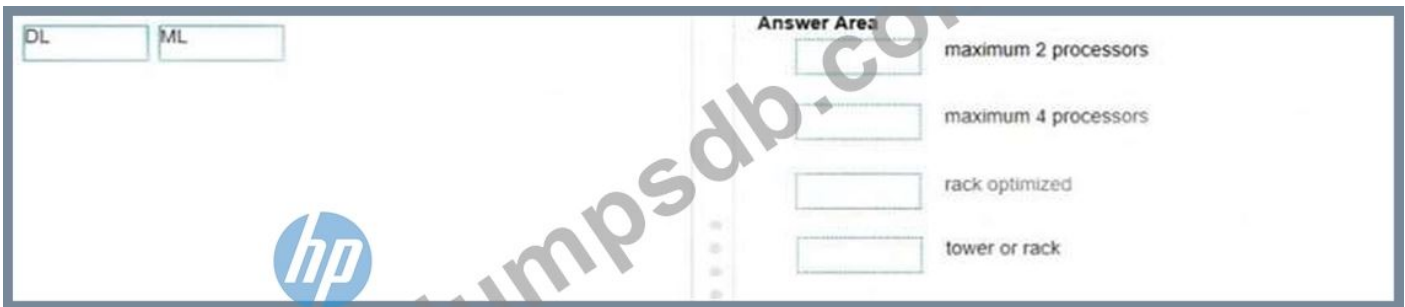

**Answer:**

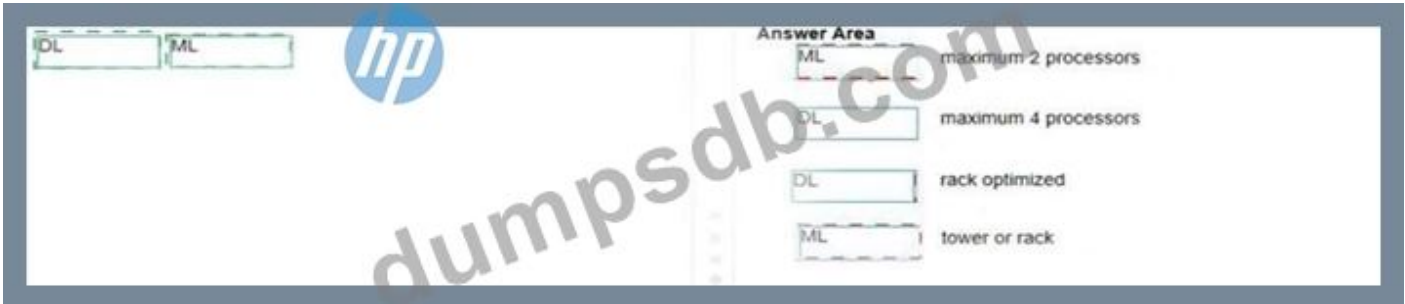

**Explanation**

ML,DL,DL,ML

**NEW QUESTION: 116**

Match each workload profile description with the corresponding profile. (Select all that apply.)



**Answer:**

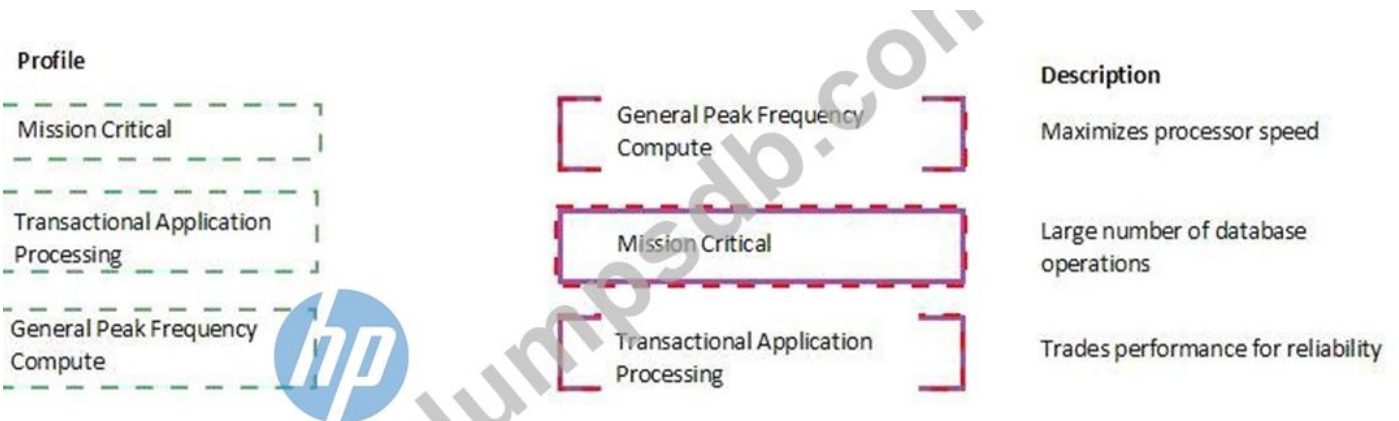

**Explanation**

Missing Critical - Large number of database operations

Transactional Application Processing - Trades performance for reliability

Frequency Compute - Maximize processor speed

**NEW QUESTION: 117**

A customer needs to share files among their Microsoft Windows servers cost-effectively and requires disaster support Which native StoreEasy features win address the customer's need? (select two) recovery

- A. Dual controller architecture
- B. Enhanced data deduplication
- C. Microsoft Azure support
- D. DFS-Replication
- E. File classification infrastructure

Answer: ([SHOW ANSWER](#))

**NEW QUESTION: 118**

You are working in a data center with multiple servers and need to update the iLO 5 user names and passwords on a regular basis.

Which tool enables you to streamline and automate this process?

- A. Central Management Console
- B. Agentless Management
- C. RESTful API
- D. iLO Amplifier Pack

Answer: D ([LEAVE A REPLY](#))

**NEW QUESTION: 119**

Match each characteristic to the correct storage type.

## Answer Area

DL      maximum 2 processors

ML      maximum 4 processors

         rack optimized

         tower or rack

Answer:

## Answer Area



### NEW QUESTION: 120

A customer is planning to deploy a branch office server rack. The environment will have the following requirements:

Single rack with 20 HPE ProLiant DL360 Gen10 Servers.

Each Server will have 6 x 10G SFP+ Ports.

Each Server will have a dedicated iLO port.

The customer requires that only two switches be used.

The customer requires separate control planes.

Which switch configuration can meet these requirements?

- A. 2 x HPE 5945 Series switches standalone
- B. 2 x HPE 5945 Series switch with IRF
- C. 2 x Aruba 8325 Series switches with VSX
- D. 2 x Aruba 8325 Series switches with backplane stacking

Answer: ([SHOW ANSWER](#))

### NEW QUESTION: 121

In which protocol are REST API requests transported?

- A. SOAP
- B. HTTP
- C. SSH
- D. CRUD

Answer: B ([LEAVE A REPLY](#))

**Valid HPE0-V14 Dumps** shared by TrainingQuiz.com for Helping Passing HPE0-V14 Exam! TrainingQuiz.com now offer the **newest HPE0-V14 exam dumps**, the TrainingQuiz.com HPE0-V14 exam **questions have been updated** and **answers have been corrected** get the **newest** TrainingQuiz.com HPE0-V14 dumps with Test Engine here:

<https://www.trainingquiz.com/HPE0-V14-practice-quiz.html> (305 Q&As Dumps, **40%OFF**)

**Special Discount: Exam-Tests)**

#### **NEW QUESTION: 122**

A customer is subject to regulatory requirements and their data is highly sensitive.

Which HPE Smart Array feature addresses their need for an additional level of security for data stored inside their server?

- A. SmartCache
- B. Rapid Parity Initialization
- C. Smart Battery backed-up write-cache
- D. Secure Encryption

**Answer: A (LEAVE A REPLY)**

#### **NEW QUESTION: 123**

A customer is moving a server from a co-location facility back into their existing data center to comply with new internal policies on data management Due to budget constraints, the customer cannot purchase any additional switches and will need to use an existing end-of-row design with HPE FlexFabric switches While the server will be installed six racks away from the switches, the total cable run with cable management is expected to be 35 m.

Which component should be selected when designing the 10 Gbps connectivity option for the server?

- A. SFP+ 10G LC SR Transceiver
- B. QSFP28 Active Optical Cable
- C. QSFP+ Active Optical Cable
- D. SFP+ Active Optical Cable
- E. SFP+ Direct Attach Copper Cable

**Answer: B (LEAVE A REPLY)**

#### **NEW QUESTION: 124**

Match the Networking Product Family to the appropriate use case:

Product	Use Case
Aruba	traditional core and top of rack (ToR) network infrastructure
FlexFabric	software-defined datacenter network with ease of automation
Altoline	open networking where customer purchases network OS separately from switch
Arista	campus edge port aggregation

**Answer:**

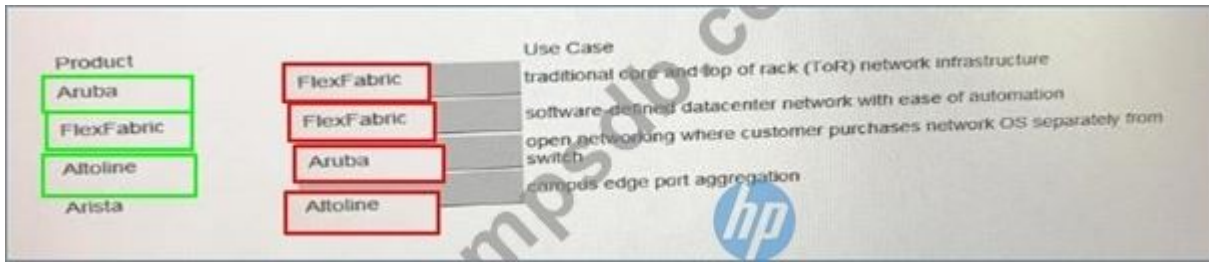

**NEW QUESTION: 125**

Which factors are used to determine RAM configuration maximum memory capacity? (Choose two.)

- A. number and model of qualified processors
- B. largest DIMM capacity qualified on the server
- C. speed of the DIMMs being used
- D. number of cores in the processor
- E. number of PCIe slots

**Answer: A,B (LEAVE A REPLY)**

Explanation/Reference: [https://support.hpe.com/hpesc/public/docDisplay?docLocale=en\\_US&docId=emr\\_na-a00027959en\\_us](https://support.hpe.com/hpesc/public/docDisplay?docLocale=en_US&docId=emr_na-a00027959en_us)

**NEW QUESTION: 126**

You are managing a HPE ProLiant rack-mount server and need to determine when the Remote Console was most recently used.

Where can you find this information?

- A. System
- B. IML
- C. iLO
- D. Audit

**Answer: (SHOW ANSWER)**

**NEW QUESTION: 127**

Match the HPE Tool with its use case. Select all that apply.

### HPE Tool

- Single Point of Connectivity Knowledge (SPOCK)
- One Config Advanced (OCA)
- Products & Solutions Now (PSNow)
- Ninja Stars
- iQuote

### Use Case

Estimate the power and cooling requirements and weight for a rack of equipment.

Check compatibility of storage components.

Download a technical presentation for a DL380 Gen10.



### Answer:

#### HPE Tool

- Single Point of Connectivity Knowledge (SPOCK)
- One Config Advanced (OCA)
- Products & Solutions Now (PSNow)
- Ninja Stars
- iQuote

#### Use Case

Estimate the power and cooling requirements and weight for a rack of equipment.

Check compatibility of storage components.

Download a technical presentation for a DL380 Gen10.

One Config Advanced (OCA)

Single Point of Connectivity Knowledge (SPOCK)

Products & Solutions Now (PSNow)

### Explanation

One Config Advanced (OCA) - Estimate the power and cooling requirements and weight for a rack of equipment

Single Point of Connectivity Knowledge (SPOCK) - Check compatibility of storage components

Products and solutions Now (PSNow) - Download a technical presentation for a DL380 Gen10

### NEW QUESTION: 128

A customer recently installed a VMware environment with HPE ProLiant, HPE MSA storage, and Aruba switches.

What should you recommend to the customer to manage their support contracts with HPE?

- A. HPE Recovery Manager Central
- B. Service Pack for ProLiant
- C. HPE InfoSight
- D. HPE Insight Online

Answer: ([SHOW ANSWER](#))

### NEW QUESTION: 129

A customer is expanding from local storage to a SAN environment for the first time. They plan to future proof their environment with a 16 Gb Fibre Channel. They also want to allow for future I/O expansion with new servers.

Identify the correct server and storage to meet the customer requirements.



**Answer:**

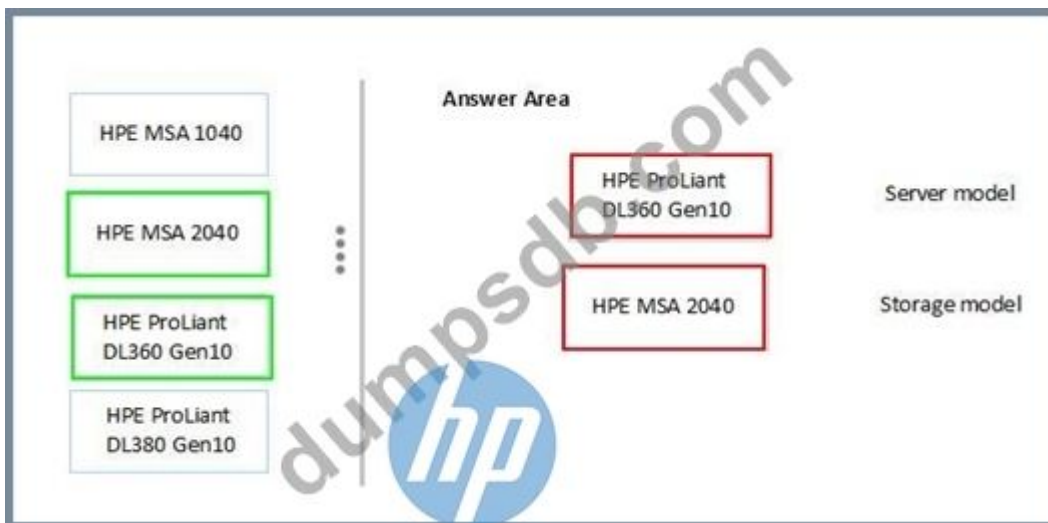

Server model - HPE ProLiant DL380 Gen10

Storage model - HPE MSA 2040

**NEW QUESTION: 130**

Match the Networking Product Family to the appropriate use case:

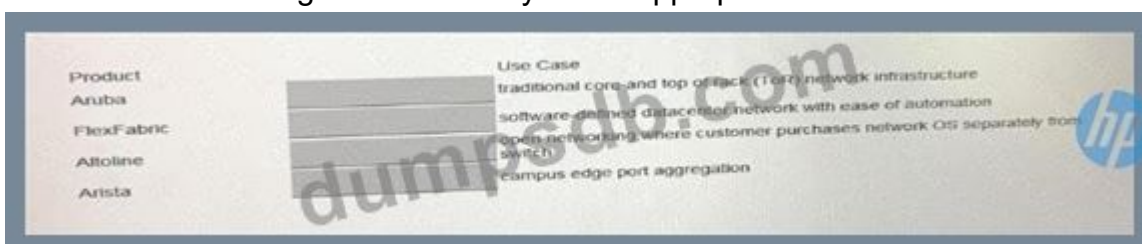

**Answer:**

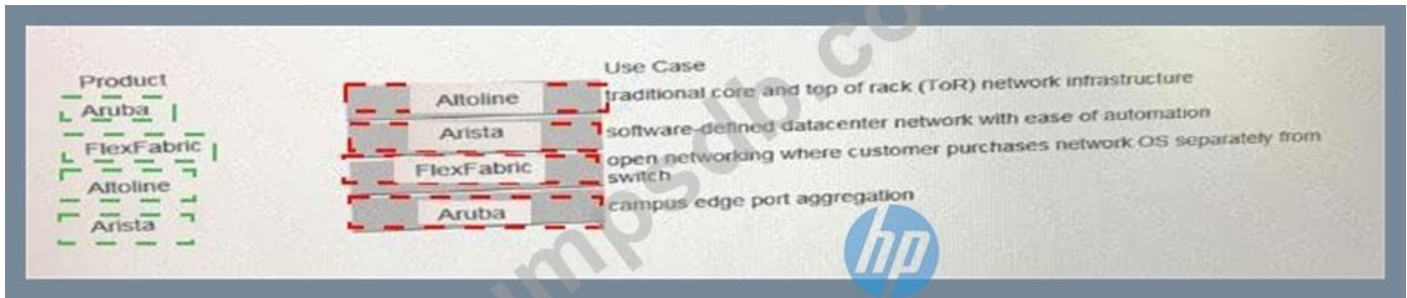

**NEW QUESTION: 131**

A customer plans to purchase five HPE DL380 Gb 2-port 530SFP Ethernet Adapters. The customer's network administrator has installed a top of rack 10 GbE switch capable of supporting copper and optical connections. The customer is already over budget and needs to keep costs down.

Which option should you recommend for connecting to the switch?

- A. 3m OM3 Fiber Optic Cables
- B. 3m Direct Attached Copper Cables
- C. 3m Cat 6A Copper Cables
- D. 3m OM2 Fiber optic cables

**Answer:** ([SHOW ANSWER](#))

**NEW QUESTION: 132**

A customer needs to update a server's firmware using the latest Support Pack for ProLiant (SPP). They use a bootable USB flash drive to do so, and they select Interactive Mode on boot. Once the device boots, they are unsure how to proceed and ask for your assistance.

What can you tell them to do to easily update the firmware?

- A. From Interactive mode, select the "Force Firmware" option.
- B. Run interactive mode from the Operating System instead.
- C. Reboot the server with the flash drive and leave in default mode.
- D. Download a new version of Smart Update Manager.

**Answer:** A ([LEAVE A REPLY](#))

**NEW QUESTION: 133**

A customer requests a quote for an HPE storage solution that meets these requirements

- \* fully redundant dual-controller storage array with no single points of failure
  - \* 1 Gb or 10 Gb iSCSI connectivity
  - \* at least four host-facing iSCSI ports
  - \* capable of expanding usable capacity in small increments of one-to-two disks
- Which HPE storage solution should be proposed?

- A. Nimble AF20Q
- B. MSA 1050
- C. D3000

D. Nimble HF20

Answer: ([SHOW ANSWER](#))

**NEW QUESTION: 134**

Refer to the exhibit.

Qty	Product#	Product Description
1	868703-B21	HPE ProLiant DL380Gen10 8SFF Configure-to-order Server
1	868703-B21 B19	HPE DL380 Gen10 8SFF CTO Server
1	826860-L21	HPE DL380 Gen10 Intel Xeon-Gold 6144 (3.5GHz/8-core/150W) FIO Processor Kit
1	826860-B21	HPE DL380 Gen10 Intel Xeon-Gold 6144 (3.5GHz/8-core/150W) Processor Kit
12	815100-B21	HPE 32GB (1x32GB) Dual Rank x4 DDR4-2666 CAS-19-19-19 Registered Smart Memory Kit
2	870757-B21	HPE 600GB SAS 12G Enterprise 15K SFF(2.5in) SC 3yr Wty Digitally Signed Firmware HDD
2	727055-B21	HPE Ethernet 10Gb 2-port 562SFP+ Adapter
1	P01366-B21	HPE 96W SmartStorage Battery (up to 20 Devices) with 145mm Cable Kit
1	804331-B21	HPE Smart Array P408i-a SR Gen10 (8 Internal Lanes/2GB Cache) 12G SAS Modular Controller
2	865408-B21	HPE 500W Flex Slot Platinum Hot Plug Low Halogen Power Supply Kit
1	BD505A	HPE iLO Advanced 1-server License umep 3yr Support on iLO Licensed Features
1	P8B31A	HPE OneView w/o iLO including 3yr 24x7 Support 1-server FIO LTU
1	733660-B21	HPE 2U Small Form Factor Easy Install Rail Kit

A customer needs a server with four 10Gb network adapters. They need it to be configured for the best possible network throughput.

Given the BOM in the exhibit, what do you need to add to this server to meet the customer requirement?

- A. SSD Drives
- B. Smart Storage Hybrid Capacitor
- C. Secondary Riser Kit
- D. Workload Accelerator

Answer: ([SHOW ANSWER](#))

**NEW QUESTION: 135**

A customer is moving a server from a co-location facility back into their existing data center to comply with new internal policies on data management. Due to budget constraints, the customer cannot purchase any additional switches and will need to use an existing end-of-row design with HPE FlexFabric switches. While the server will be installed six racks away from the switches, the total cable run with cable management is expected to be 35 m.

Which component should be selected when designing the 10 Gbps connectivity option for the server?

- A. QSFP+ Active Optical Cable
- B. SFP+ 10G LC SR Transceiver
- C. SFP+ Active Optical Cable
- D. SFP+ Direct Attach Copper Cable
- E. QSFP28 Active Optical Cable

Answer: C ([LEAVE A REPLY](#))

**NEW QUESTION: 136**

What should you configure to limit the scope of broadcast domains in an Ethernet network?

- A. Trunks
- B. VSAN
- C. Static ARP
- D. VLAN

**Answer: (SHOW ANSWER)**

Reference:

<https://assets.ext.hpe.com/is/content/hpedam/documents/a00069000-9999/a00069468/a00069468enw.pdf>

**Valid HPE0-V14 Dumps** shared by TrainingQuiz.com for Helping Passing HPE0-V14 Exam! TrainingQuiz.com now offer the **newest HPE0-V14 exam dumps**, the TrainingQuiz.com HPE0-V14 exam **questions have been updated** and **answers have been corrected** get the **newest** TrainingQuiz.com HPE0-V14 dumps with Test Engine here:

<https://www.trainingquiz.com/HPE0-V14-practice-quiz.html> (305 Q&As Dumps, **40%OFF**

**Special Discount: Exam-Tests)**

**NEW QUESTION: 137**

You need to review a warning on a Nimble storage array.

Click on the menu option that displays this information.



**Answer:**

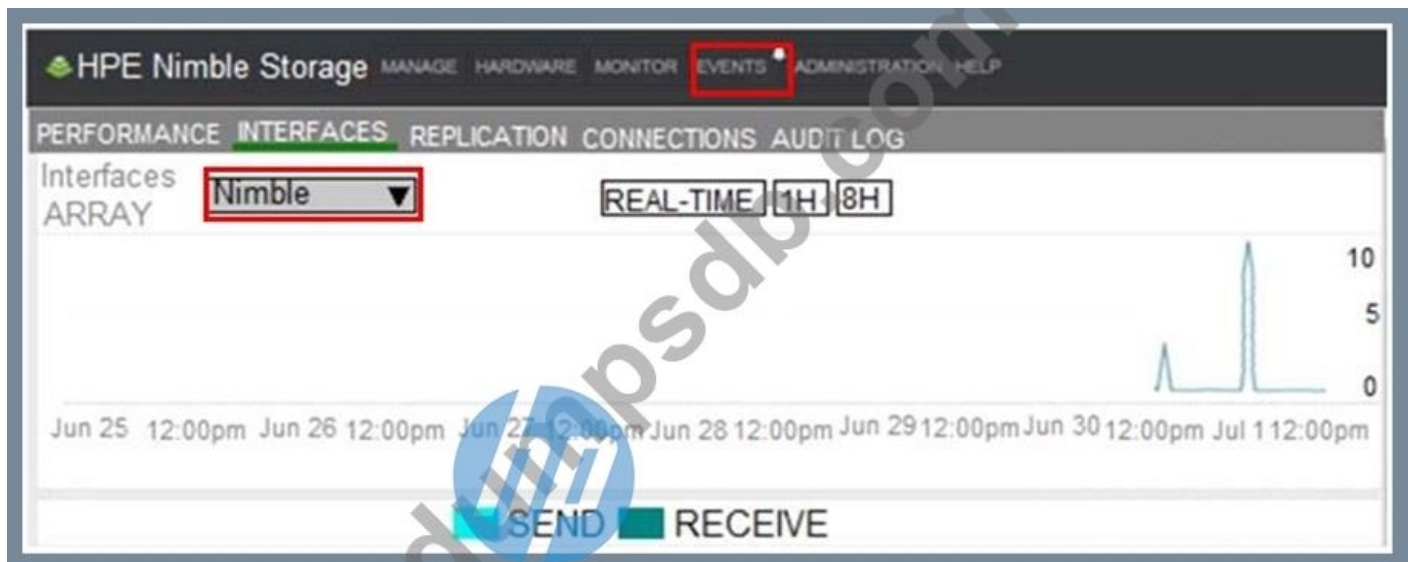

### NEW QUESTION: 138

You have configured a port on an HPE FlexFabric 5900 series switch that is connected to a VMware ESXi server to support multiple VLANs.

```
interface Ten-GigabitEthernet 1/0/11 description server ESXi01 -eth1 port link-type trunk
port trunk permit vlan 50 port trunk permit vlan 2 port trunk pvid vlan 50
```

Given the configuration above, what should happen to any of the untagged traffic coming from the VMware ESXi host?

- A. The untagged traffic will be transmitted in vlan 2.
- B. The untagged traffic will be transmitted in vlan 50.
- C. The untagged traffic will be transmitted in vlan 1.
- D. The untagged traffic will be dropped.

**Answer: B** ([LEAVE A REPLY](#))

### NEW QUESTION: 139

A customer needs a new environment to support an ERP system. The sizing information you received shows the following requirements:

3 servers with dual AMD processors, 256GB RAM, and 10Gb network connectivity

10TB of high performance shared storage

Cloud-based performance monitoring and analytics

The customer prefers rack mounted equipment.

Identify the components that will meet the customer requirements, then drag the correct components on the left to their appropriate location in the environment on the right.

Select and Place:

Answer Area

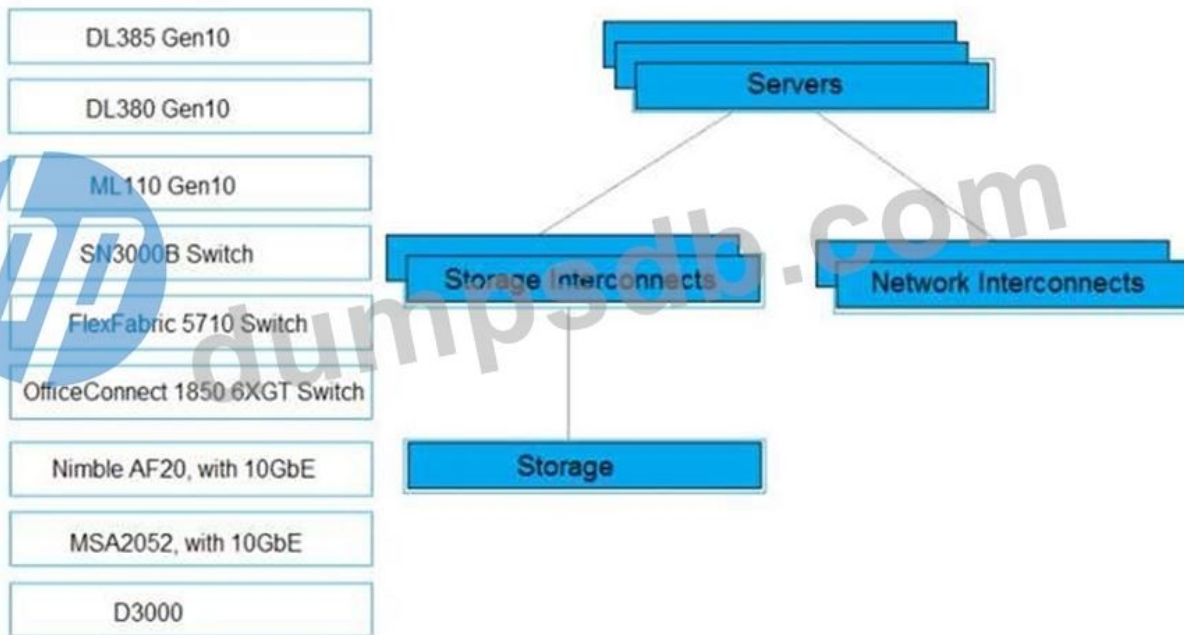

Answer:

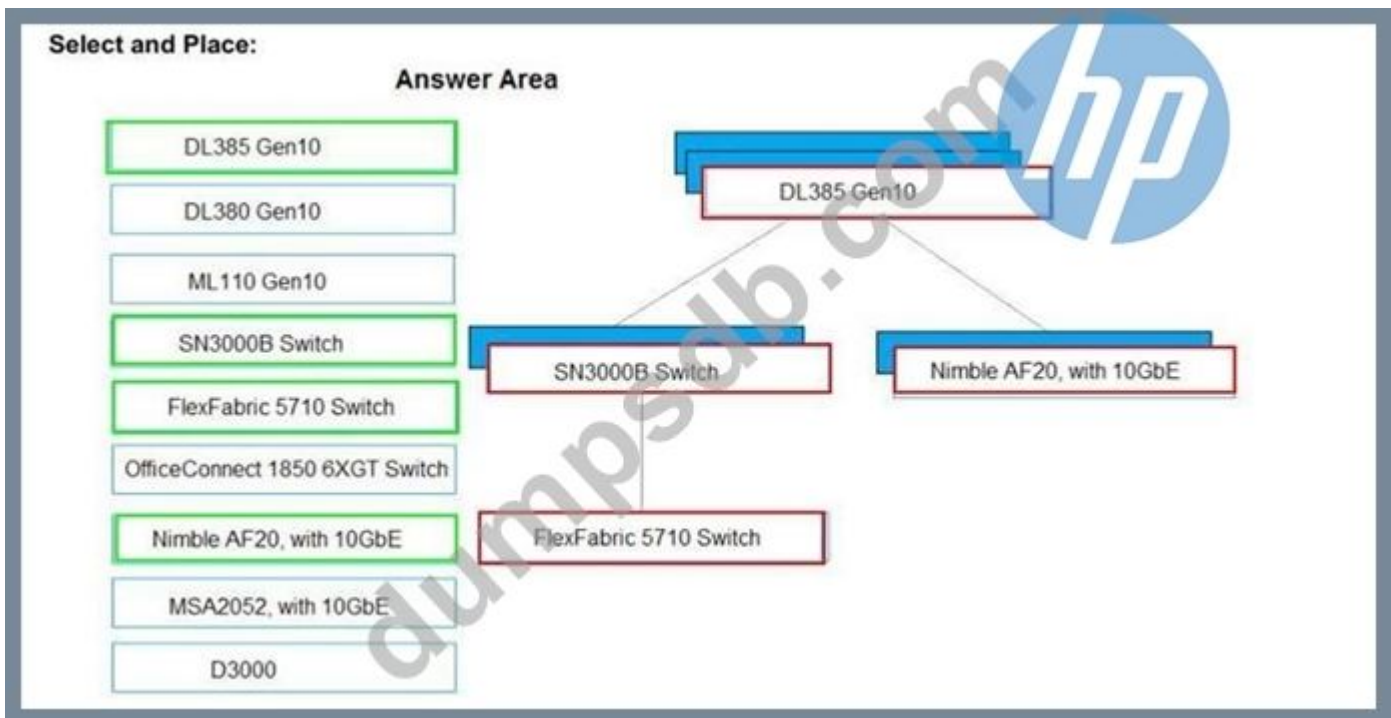

### NEW QUESTION: 140

A customer has requested that you provide them with an architecture and bill-of-materials for a stack of top-of-rack switches. The customer has 34 HPE DL360 servers in the rack, each with four 1GBASE-T Ethernet ports which need to be connected to the network.

The customer is upgrading 50% of the 1GBASE-T Ethernet ports on the servers to 10GBASE-T Ethernet ports and needs the switching to support the upgraded servers. They are opposed to a chassis switch, and want to keep their number of managed devices on the network to a minimum. Which architecture meets the customer requirements?

A. Two VSX stacks of two Aruba 8320 48-port 1/10GBASE-T switches

- B. Two IRF stacks of two HPE 5710 48-port 1/10GBASE-T switches
- C. One IRF stack of four HPE 5710 48-port 1/10GBASE-T switches
- D. One VSX stack of four Aruba 8320 48-port 1/10GBASE-T switches

Answer: ([SHOW ANSWER](#))

**NEW QUESTION: 141**

A customer is planning an upgrade to their network. They need to combine multiple existing switches into one virtual device.

Which technology should the customer configure on their existing switches?

- A. Intelligent Resilient Framework (IRF)
- B. Link Aggregation Control Protocol (LACP)
- C. Multi-chassis Link Aggregation (MLAG)
- D. Rapid Spanning Tree Protocol (RSTP)

Answer: ([SHOW ANSWER](#))

**NEW QUESTION: 142**

Which statement is true regarding configuring memory in an HPE ProLiant server?

- A. LRDIMMS in 64 GB and 128 GB can be mixed.
- B. Different capability DIMMs of the same speed can be mixed.
- C. RDIMM and LRDIMMs can be mixed in one system.
- D. The first CPU memory channel must be fully populated before the second.

Answer: ([SHOW ANSWER](#))

**NEW QUESTION: 143**

Refer to the exhibit.

Qty	Product#	Product Description
1	868703-B21	HPE ProLiant DL380Gen10 8SFF Configure-to-order Server
1	868703-B21 B19	HPE DL380 Gen10 8SFF CTO Server
1	826860-L21	HPE DL380 Gen10 Intel Xeon-Gold 6144 (3.5GHz/8-core/150W) FIO Processor Kit
1	826860-B21	HPE DL380 Gen10 Intel Xeon-Gold 6144 (3.5GHz/8-core/150W) Processor Kit
12	815100-B21	HPE 32GB (1x32GB) Dual Rank x4 DDR4-2666 CAS-19-19-19 Registered Smart Memory Kit
2	870757-B21	HPE 600GB SAS 12G Enterprise 15K SFF(2.5in) SC 3yr Wty Digitally Signed Firmware HDD
2	727055-B21	HPE Ethernet 10Gb 2-port 562SFP+ Adapter
1	P01366-B21	HPE 96W SmartStorage Battery (up to 20 Devices) with 145mm Cable Kit
1	804331-B21	HPE Smart Array P408i-a SR Gen10 (8 Internal Lanes/2GB Cache) 12G SAS Modular Controller
2	865408-B21	HPE 500W Flex Slot Platinum Hot Plug Low Halogen Power Supply Kit
1	BD505A	HPE iLO Advanced 1-server License 1-yr Support on iLO Licensed Features
1	P8B31A	HPE OneView w/o iLO including 3yr 24x7 Support 1-server FIO LTU
1	733660-B21	HPE 2U Small Form Factor Easy Install Rail Kit

A customer needs a server with four 10Gb network adapters. They need it to be configured for the best possible network throughput.

Given the BOM in the exhibit, what do you need to add to this server to meet the customer requirement?

- A. Smart Storage Hybrid Capacitor

- B. Workload Accelerator
- C. SSD Drives
- D. Secondary Riser Kit

**Answer: B ([LEAVE A REPLY](#))**

#### **NEW QUESTION: 144**

What does the term composable mean when applied to HPE infrastructure?

- A. pay-per-use consumption models
- B. hardware-defined infrastructure
- C. to provide all-flash like performance, but at a hybrid price point
- D. to simplify and accelerate DevOps and business innovation

**Answer: B ([LEAVE A REPLY](#))**

Reference:

20data%20center.

#### **NEW QUESTION: 145**

Which hardware and software components make up a Nimble dHCI infrastructure?

- A. HPE M-Series switch, HPE ProLiant DL servers, HPE Nimble, and Hyper-V
- B. Aruba Switches, HPE Synergy, HPE Nimble, and Hyper-V
- C. Aruba Switches, HPE Synergy, HPE Nimble, and VMware
- D. HPE M-Series switch, HPE ProLiant DL servers, HPE Nimble, and VMware

**Answer: ([SHOW ANSWER](#))**

#### **NEW QUESTION: 146**

You are troubleshooting a customer's HPE ProLiant rack-mount server. The customer has configured the server in Legacy Boot BIOS Mode and is trying to boot from a USB 3.0 drive. The server will not boot from the drive.

What should you do?

- A. Use the internal USB 3.0 connector.
- B. Set the USB 3.0 mode to Auto.
- C. Use the front-facing USB 3.0 connector.
- D. Set the USB 3.0 mode to Enabled.

**Answer: D ([LEAVE A REPLY](#))**

#### **NEW QUESTION: 147**

A customer requires a high level of network bandwidth and reliability. You are installing a pair of HPE switches that can provide redundancy with multiple connections between them for high availability and faster throughput.

Which technology should you configure on the switches to enable the capability the customer requires?

- A. Multiple Spanning Tree Protocol (MSTP)

- B. Virtual Extensible Local Area Network (VxLAN)
- C. Multichassis Link Aggregation (MLAG)
- D. Rapid Spanning Tree Protocol (RSTP)

**Answer: C (LEAVE A REPLY)**

**NEW QUESTION: 148**

Match each workload profile description with the corresponding profile. (Select all that apply.)

Profile	[ ]	Description
Mission Critical	[ ]	Maximizes processor speed
Transactional Application Processing	[ ]	Large number of database operations
General Peak Frequency Compute	[ ]	Trades performance for reliability

**Answer:**

Profile	[ ]	Description
Mission Critical	[ ]	Maximizes processor speed
Transactional Application Processing	[ ]	Large number of database operations
General Peak Frequency Compute	[ ]	Trades performance for reliability

Explanation

Missing Critical - Large number of database operations (Trades Performance reliability)  
 Transactional Application Processing - Trades performance for reliability (Large number of DB Operation)  
 General Peak Frequency Compute - Maximize processor speed

**NEW QUESTION: 149**

Which HPE remote management tool offers simplified warranty and contract case management?

- A. HPE InfoSight
- B. HPE Insight Online
- C. HPE iLO Advanced
- D. HPE Smart Update Manager

**Answer: B (LEAVE A REPLY)**

Explanation/Reference: <https://h20195.www2.hpe.com/v2/getpdf.aspx/c04123234.pdf>

**NEW QUESTION: 150**

You need to create a dynamic bridge-aggregation group on a FlexFabric switch to ensure the ports are automatically configured with the applicable bridge-aggregation interface configuration. Drag the steps on the left into their appropriate order in the answer area on the right.

**Answer:**

**NEW QUESTION: 151**

A customer Has a data center with third-party routers and firewalls You are designing a new data center network switch architecture consisting of FlexFabric switching for the data network and ArubaOS-Switch switching for the out-of-band management network.

The customer needs a network management platform with the capabilities to manage and monitor the entire environment Which management platform meets the customer requirements?

- A. Aruba Central
- B. HPE OneView
- C. Aruba Airwave
- D. HPE IMC

**Answer: D (LEAVE A REPLY)**

**Valid HPE0-V14 Dumps** shared by TrainingQuiz.com for Helping Passing HPE0-V14 Exam! TrainingQuiz.com now offer the **newest HPE0-V14 exam dumps**, the TrainingQuiz.com HPE0-V14 exam **questions have been updated** and **answers have been corrected** get the **newest** TrainingQuiz.com HPE0-V14 dumps with Test Engine here:

<https://www.trainingquiz.com/HPE0-V14-practice-quiz.html> (305 Q&As Dumps, **40%OFF**)

**Special Discount: Exam-Tests)**

**NEW QUESTION: 152**

A customer has the following requirements:

- \* two or more 10Gb SFP+ uplinks
- \* downlink ports capable of 1Gb or 10Gb operation over CAT6a or CAT7 cables.
- \* 24 downlink ports

Which HPE tool would you use to help choose an HPE network solution that meets the customer requirements?

- A. HPE Switch Selector
- B. HPE SAF
- C. HPE SPOCK
- D. HPE NinjaSTARS

**Answer:** ([SHOW ANSWER](#))

### **NEW QUESTION: 153**

A customer requires a management solution that will provide email notifications if hardware errors occur on their servers.

Which management solution provides this functionality?

- A. HPE SUM
- B. HPE SUT
- C. iLO Advanced Edition
- D. UEFI System Configuration

**Answer:** ([SHOW ANSWER](#))

### **NEW QUESTION: 154**

A customer with a Microsoft server environment wants to consolidate their employee home directories and other company file shares presented from an appliance as a single name space.

Which HPE product should you recommend to the customer?

- A. StoreOnce
- B. StoreEasy
- C. SimpliVity
- D. MSA storage

**Answer:** ([SHOW ANSWER](#))

Explanation/Reference: [https://support.hpe.com/hpesc/public/docDisplay?docId=a00076230en\\_us&docLocale=en\\_US](https://support.hpe.com/hpesc/public/docDisplay?docId=a00076230en_us&docLocale=en_US)

### **NEW QUESTION: 155**

A customer needs a new environment to support an ERP system. The sizing information you received shows the following requirements:

- \* 3 servers with dual AMD processors, 256GB RAM, and 10Gb network connectivity
- \* 10TB of high performance shared storage
- \* Cloud-based performance monitoring and analytics

The customer prefers rack mounted equipment.

Identify the components that will meet the customer requirements, then drag the correct components on the left to their appropriate location in the environment on the right.

Select and Place:

Answer Area

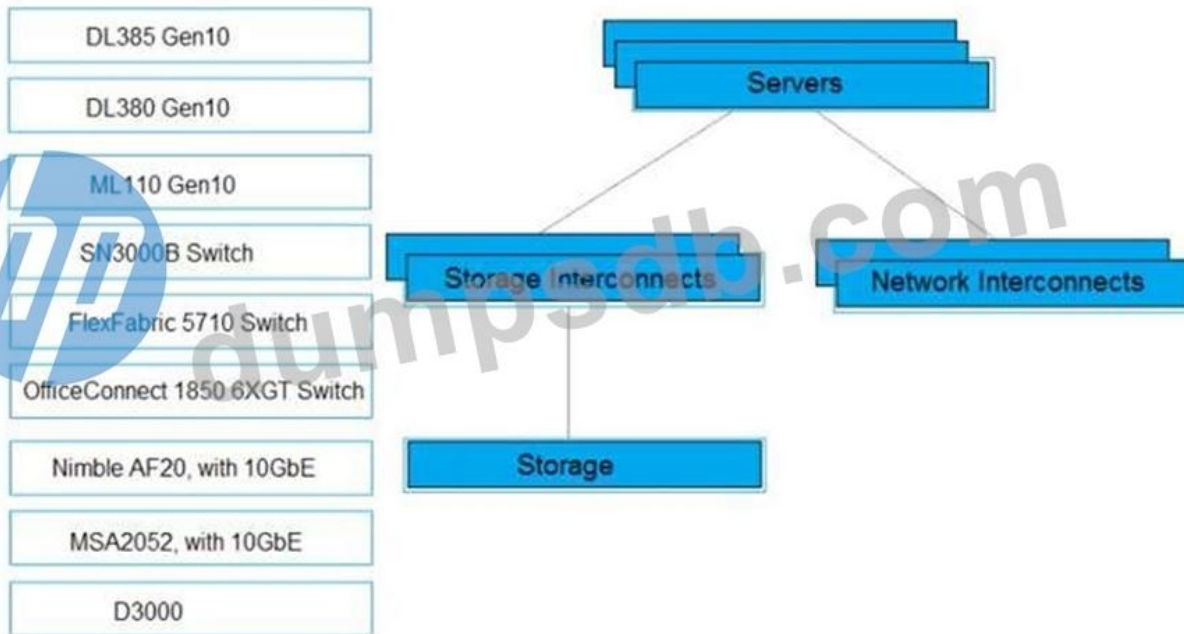

Answer:

Select and Place:

Answer Area

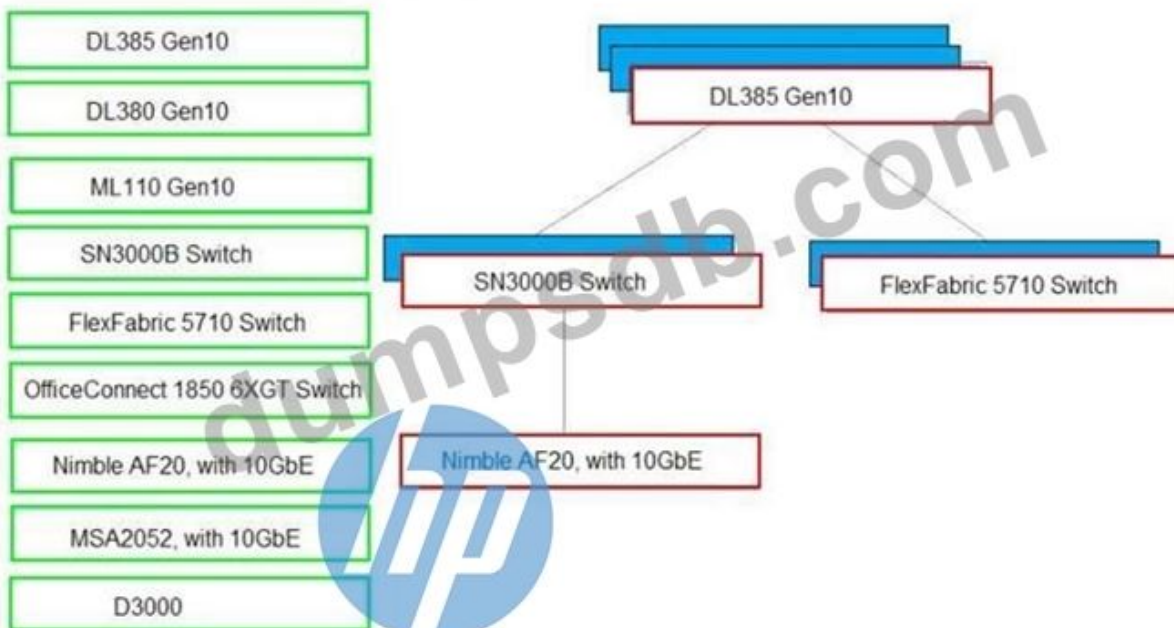

**NEW QUESTION: 156**

A customer just purchased a ProLiant 300 series Gen10 server and wants to install the latest version of Windows.

Which feature of this server will assist the customer with the initial Windows installation?

- A. HPE SSA Diagnostics
- B. HPE SmartStart
- C. Smart Storage Administrator

D. Intelligent Provisioning

**Answer: (SHOW ANSWER)**

Reference: <https://community.hpe.com/t5/Alliances/Get-HPE-Gen10-Servers-with-Windows-Server-2019-up-and-Running-in/ba-p/7066128#.XnxeVG5RWQ4>

**NEW QUESTION: 157**

Which tool provides a report on the current usage levels and life span of some installed read-intensive flash drives?

A. Central Management Console

B. Intelligent Provisioning

C. Integrated Management Log

D. Smart Storage Administrator

**Answer: (SHOW ANSWER)**

**Valid HPE0-V14 Dumps** shared by TrainingQuiz.com for Helping Passing HPE0-V14 Exam! TrainingQuiz.com now offer the **newest HPE0-V14 exam dumps**, the TrainingQuiz.com HPE0-V14 exam **questions have been updated** and **answers have been corrected** get the **newest** TrainingQuiz.com HPE0-V14 dumps with Test Engine here:

<https://www.trainingquiz.com/HPE0-V14-practice-quiz.html> (305 Q&As Dumps, **40%OFF**

**Special Discount: Exam-Tests**)